



BHARAT HEAVY ELECTRICALS LIMITED
HEEP HARIDWAR INDIA-PIN 249403
FAX NO: 0091 1334 226462
PHONE NO: 0091 1334 284142

Open Tender Enquiry No: T/3990/19/4690K2

M/s.....

Sub: BHEL-HEEP/OPEN-TENDER (Turbine) / 2020

Dear Sir,

The Heavy Electricals Equipment Plant (HEEP) located in Haridwar, India is one of the major manufacturing plants of Bharat Heavy Electricals Ltd. The core business of HEEP includes design and manufacture of large steam and gas turbines, turbo generators and so on.

Sealed tenders with the **Tender No.** and **opening date** clearly super scribed on the cover are invited from the manufacturers (registered as well as unregistered) for the supply of the items Heat Resistant steel bars for turbine blades **as per Annexure-2 enclosed.**

SPECIAL INSTRUCTIONS:

- 1) Late delivery Penalty for Late Deliveries shall be applicable @0.5% per week or part thereof on the value of respective delayed supplies subject to maximum of 10% of the value of respective delayed supplies. If vendor do not confirm late delivery penalty clause in your offer, then it shall be presumed to be acceptable. No further clarification shall be asked in this regard after opening of techno-commercial bid part-1.
- 2) Foreign vendors to either quote third party inspection charges (LRS/BV/TUV) separately in their offer or vendor to mention that third party inspection charges are included in the quoted prices of the offer. If vendor do not quote third party inspection charges or do not mention that third party inspection charges are included in the quoted prices, then it shall be presumed that third party inspection charges are included in the quoted prices of the offer. No further clarification shall be asked in this regard after opening of techno-commercial bid part-1.
- 3) **For foreign vendor** – Vendor to furnish quality plan in the enclosed QP format (Annexure-5) along with offer for BHEL review and approval. Inspection shall be done by third party inspection agency (LRS/TUV/BV) as per finally NTPC/BHEL approved QP.
- 4) **For Indigenous vendor** – Vendor to furnish quality plan in the enclosed QP format (Annexure-5) along with offer for BHEL review and approval. Inspection shall be done by NTPC as per finally NTPC/BHEL approved QP.
- 5) End of bars should be squared and sawed off properly.
- 6) There should be proper stamping of cross section, Heat number, material grade, vendor code/vendor name on each bar at the pitch of one meter.
- 7) Quantity tolerance should be (+/-10) %.

- 8) **Price bid of only customer approved vendors shall be opened. Credentials shall be asked from customer unapproved vendor if required.**
- 9) All vendors to provide point wise reply/confirmation along with relevant supporting documents to each and every point of Pre-Qualification Requirement/PQR (**Annexure-1**) for items ('Heat Resistant Steel Bars for Turbine Blades') of material codes HW1060379058 & HW1060379066. Non-compliance of these may lead to rejection of offer as these are essential condition for participating in tender enquiry.
- 10) BHEL standard payment term i.e "payment after receipt and acceptance of material/item at HEEP, BHEL-store "as per **General Instruction and Standard Terms & Condition (GISTC), Version April 2019, Rev:04** shall be applicable.
- 11) The quotation shall be valid for a **minimum period of 120 days**, effective from the date of tender opening.
- 12) Vendor to ensure that their quoted rates are not more than those quoted for any other customer including other BHEL units.
- 13) Delivery is not sacrosanct. Vendor to offer best delivery schedule.
- 14) The total quantity may undergo change at the time of ordering.
- 15) Test certificate and Guarantee certificate to be provided by vendor as per specification.
- 16) For this procurement, Public Procurement (Preference to Make in India), Order 2017 dated 15.06.2017, 28.05.2018 & 29.05.2019 and subsequent Orders issued by the respective Nodal Ministry shall be applicable even if issued after issue of this NIT but before finalization of contract / PO / WP against this NIT.
In the event of any Nodal Ministry prescribing higher or lower percentage of purchase preference and/ or local content in respect of this procurement, same shall be applicable.
Default purchase preference under Make in India order shall be 20% to suppliers with default minimum local content of 50% for all items / works / services.

For further details, please refer latest version of GISTC.

Procurements where the Estimated value to be procured is less than Rs. 5 lakhs shall be exempted from Public Procurement (Preference to Make in India), Order 2017 dated 15.06.2017, 28.05.2018 & 29.05.2019.

- 17) It may be noted that documents submitted with the offer/bid shall be signed and stamped in each page by authorized representative of the bidder.
- 18) Due to lockdown/COVID-19, if you are unable to submit hardcopy of your Offer/Bid within due date you can submit your Offer/Bid to the following e-mail address:
tendercell.heep@bhel.in

For submission of bids through e-mail following procedure must be followed.

I. Bidder have to submit their bid into two parts: - **Techno-Commercial Bid** (Part-I Bid) and **Price Bid** (Part-II Bid) in two separate password protected pdf files before 01:45 PM **on the date of Techno-Commercial Bid (Part-I Bid) opening.** Names of pdf files attached in e-mail should be as follows:

- Techno-Commercial Bid (Part-I Bid)_Tender Enquiry No_due date of tender
- Price Bid (Part-II Bid)_Tender Enquiry No._ due date of tender

II. The subject of the e-mail for offer submission shall be clearly specified as under:

- Tender Enquiry No..... : Due Date of tender:

III. The Techno-Commercial Bid (Part-I Bid) & Price Bid (Part-II Bid) shall be in two separate password protected pdf files and the size of the all attachments in one e-mail should not be more than 10 MB.

IV. In case size of offer is more than 10 MB, the attachments may be sent in separate e-mail and all e-mails should be in continuation. Name of pdf files and subject of all e-mails should be as per point no. I & II as above.

V. Password of pdf files should be shared by bidders at same e-mail ID (i.e. tendercell.heep@bhel.in) as under:

- **For Techno-Commercial Bid (Part-I Bid):** Vendor to share the password between 2:00 PM (IST) to 4:00 PM (IST) on the day of **Techno-Commercial (Part-I Bid) opening** (i.e. on the due date). However, if password is not received up to 04:00 PM (IST) on due date of part-1, such bids may not be opened and may be ignored by BHEL.
- **Price Bid (Part-II Bid):** Vendor to share the password between 2:00 PM (IST) to 4:00 PM (IST) on the day of **Price Bid (Part-II Bid) opening**. After techno-commercial scrutiny of offers, the price-bid opening date will be intimated by BHEL to techno-commercially acceptable bidders. However, if password is not received up to 04:00 PM (IST) on the day of Price Bid opening, such bids may not be opened and may be ignored by BHEL.

VI. Submission of offer through e-mail shall be considered as consent to open the Offer/Bid without physical witnessing the event by bidder.

19) Also please note that "On bid opening date, vendor/their authorized representatives who are interested to witness bid opening can sit in reception and view live streaming of bid opening on TV".

20) The remaining terms shall be as per **GENERAL INSTRUCTION AND STANDARD TERMS & CONDITION (GISTC), VERSION April 2019, Rev:04**

The tender documents can be downloaded from our web site www.bhel.com or www.bhelhwr.co.in. After downloading the tender documents from web site, while submitting the tender as detailed in "Instruction to Bidders", intending vendors must submit Tender Fee of Rs. 2,000/- (Rupees two thousand only) in the form of Pay Order / Demand Draft (drawn in favor of 'BHEL HARIDWAR') only. It may be noted that if hard copy of any tender document is required, then the same may be collected against copy of Pay Order / Demand Draft of requisite tender fee (while original to be submitted with Part-I). **However, if no hard copy of any tender documents are required from BHEL, no tender fee is required to be submitted.**

Vendors must also remit the **requisite EMD (Earnest Money Deposit) of Rs. 1,50,000/- (Rupees one lakh fifty thousand only)** in the form of Pay Order / E-payment / Demand draft (drawn in favor of 'BHEL HARIDWAR'). In case of foreign bidders e-payment may also be accepted as EMD. **If EMD is not submitted along with the offer (Part-I) then the offer shall be out rightly rejected.**

For E-Payment, the RTGS details are mentioned as below:

Bank Details	SWIFT Details of bank	Contact Details of Banker
STATE BANK OF INDIA RANIPUR BRANCH, OPP: BHEL MAIN GATE, SECTOR-5, RANIPUR, HARIDWAR, UTTRAKHAND, INDIA PIN CODE : 249403	SWIFT NO: SBININBB225 CC ACCOUNT NO :10667995458 IFSC CODE : SBIN0000586	Name: Sh. Sudhir Sharma Design: Chief Manager (IBD) Contact No. +91 1334 224201 Phone: +91 1334 226125 Fax: +91 1334 226512

Following HEEP BHEL Hardwar PMD SL055 approved vendors are exempted from submission of EMD whose vendor code are mentioned below: -

SL. NO.	MATERIAL CODE	PMD VENDOR CODE
1	HW1060379058	M82012
2	HW1060379066	

Please submit separate drafts for EMD and tender fee in an envelope super-scribed with bold letters “EMD & Tender Fee” to be submitted with Part-I.

Micro & Small Enterprises (MSEs) are exempted from submission of EMD and/or Tender fees. Documents as detailed in **GENERAL INSTRUCTIONS AND STANDARD TERMS & CONDITIONS (GISTC), Version April 2019, Rev:04** hoisted on our website www.bhelhwr.co.in are to be submitted for availing exemption from submission of Tender Fees & EMDs.

BHEL will forfeit the EMD if, the successful bidder / vendor refuses to honor the order after award of the same on him and / or withdraws his bid and / or unilaterally changes the offer and / or any of its terms & conditions within the validity period.

Tenders will be received in Tender Box kept in Tender Room and should be addressed to:

**THE HEAD OF MATERIAL MANAGEMENT,
Heavy Electrical Equipment Plant,
Bharat Heavy Electricals Limited,
HARIDWAR-249403 (Uttarakhand), INDIA.**

The date for opening of tender shall be 08.06.2020. Tenders will be received up to 1.45 P.M. on **08.06.2020** and opened on the same day at 2.00 P.M. in the Tender Room. **Please note that tender received after due date & time (1.45PM on 08.06.2020) will not be REPEAT will not be opened.** BHEL will not be responsible for any type of postal / courier delay.

Bids shall be opened at 2 PM on the due date in the presence of authorized representative of the bidders who may like to be present. The authorized representative should bring authority letter from their parent company (Manufacturer) for the specific tender no. attending the bid opening.

Amendments/Corrigendum, if any, will be hosted only on the websites mentioned above. Other terms and conditions will be as per tender documents.

Foreign and Indigenous bidders against open tender have to obtain class – III DSCs. Procedure for application is available on www.bhel.com.

Vendors operating from BHEL quarters, unauthorized colonies on BHEL land and Dharamshalas/ hotels shall not be considered, hence such vendors need not apply. Any vendor who is under hold (for the item)/ delisted/ banned with BHEL on date of opening of Part – 1 will not be allowed to quote for this tender. In case their offer is received, it may be out rightly rejected.

Please submit your offer only for the above requirement subject to our **GENERAL INSTRUCTIONS AND STANDARD TERMS & CONDITIONS (GISTC), Version April 2019, Rev:04**. Please visit our site www.bhelhwr.co.in for **General Instructions and Standard Terms & Conditions (GISTC), Version April 2019, Rev:04** for Tender Enquiries. All the bidders/vendors must ensure compliance of these GISTC.

Unregistered vendors may please visit our site www.bhel.com for filing up the Supplier Registration Form. Copy of filled Supplier Registration Form (SRF) may be submitted along with the offer.

KINDLY READ "INSTRUCTIONS TO BIDDERS." QUOTATION NOT IN ACCORDANCE WITH THE INSTRUCTIONS ARE LIABLE TO BE DISQUALIFIED AND IGNORED.

INSTRUCTIONS TO BIDDERS FOR OPEN TENDER

Definition

Registered Vendors - Are those who are registered with BHEL, Haridwar for Megawatt rating/ Size/ Weight of tendered items in respective material grade or machining of such items.

Un-registered Vendors - Are those who are not registered with BHEL, Haridwar for Megawatt rating/ Size/ Weight of tendered items in respective material grade or machining of such items.

ESSENTIAL INSTRUCTIONS

* Un-registered vendors may be approved by BHEL, if found suitable, on the basis of data furnished by them in Supplier Registration Form (SRF) for Foreign Vendors or Indigenous Vendors (as applicable).

* BHEL team may visit the vendor (s) works for verification of capability and capacity claimed in tender Documents/offer (s).

* The tenders shall be submitted in **two parts** in separate sub-envelopes clearly super scribing type of bid, tender no., due date and the name of vendor with full contact details.

Part I –

- **EMD**
- Tender fee (if hard copy insisted from BHEL)
- Documents as detailed in GISTC by MSE Supplier for availing benefits intended for MSE suppliers.
- Point wise reply/confirmation to both **Pre-qualifying requirement (PQR) Annexure 1** along with all necessary supporting documents in one go. **Non-compliance of this may lead to rejection offer.**
- Quality plan format (**Annexure -5**) duly signed along with the offer.
- Techno- Commercial Bid - it should be replica of price bid (copy of price bid without price part) in line with technical requirement as per drawings and documents.

Part-II -

- Price Bid

All the sub-envelopes (Part-I, Part-II) to be put in a single covering envelope indicating tender no., due date and the name of vendor, e-mail id, with full contact details. Offer should be complete in all respect (i.e. Part-I, Part-II). BHEL may decide to ignore the offer in case of submission of incomplete offer.

* Please submit your offer according to **General Instructions and Standard Terms & Conditions (GISTC), Version April 2019, Rev:04** for Tender Enquiries. Please visit our site **www.bhelhwr.co.in** for GISTC. All the bidders/vendors must ensure compliance of these **GISTC (VERSION: Version April 2019, Rev:04). GISTC (VERSION: Version April 2019, Rev:04)** can also be referred by login to B2B Portal for Vendors.

REFERENCES:

Annexure-1 (Pre-Qualification Requirement/PQR)

Annexure-2 (Item Details)

Annexure-3 (General Instructions and Standard Terms & Conditions (GISTC), Version April 2019, Rev:04)

Annexure- 4 {Order 2017 dated 15.06.2017 & 28.05.2018 & 29.05.2019 (Preference to make in India)}

Annexure-5 (Quality Plan Format)

Annexure- 6 (Specification)

ANNEXURE -1 (PQR)

Indent No.: 20194690

Item: Rectangular Flat bars of different cross section for turbine blades

Material Grade: X13CrMoCoVNbNB9-2-1, Specification: HW10679, Rev 00

Minimum Qualification Requirement:

1.0 Experience Requirement:

1.1 Vendor must have experience of manufacturing and supplying rectangular bars in material grade X13CrMoCoVNbNB9-2-1. Material supplied in hardened and tempered condition will only be considered for experience. In support of above vendor to submit experience details preferably in format given below:

Sl. No	Name of customer	Purchase order No	Size	Date of supply	Quantity

1.2 Documentary evidence (like un-priced purchase order copy, test certificate covering chemical & mechanical properties, heat treatment details, dimensions etc.) in support of experience to be submitted for material grade X13CrMoCoVNbNB9-2-1.

2.0 Prerequisite requirement for approval of any vendor is process qualification as per clause 6.0 of enquiry specification.

a) Vendor to submit process qualification test results, if carried out earlier.

b) In case process qualification results as per clause 2(a) is not available, vendor must carry out process qualification test and submit the reports to BHEL.

Following process qualification tests shall be carried out:

- Chemical composition – As per Clause 8.1 of specification
- Mechanical Properties – As per Attachment 2 (tensile samples: ZA, ZI, ZQ, WZ; Impact Sample: KA, KQ, KI)
- Microstructure: As per Clause 8.2.2.1 & 8.2.2.2; 9.0

The samples for process qualification test are to be taken from their regular manufacturing lots and shall be duly identified by 3rd party inspection agency / customer. The details of purchase order, name of customer, rectangular cross sectional sizes, heat number, heat treatment batch number, manufacturing details (covering steel melting procedure, ingot size, reduction ratio, rolling/forging temperature, heat treatment regime followed) from which this sample has been taken are also be furnished along with process qualification results.

Process qualification tests are to be witnessed by third party inspection agency and process qualification test results are to be duly certified by third party inspection agency like Lloyds/TUV/BVQI etc.

c) Process qualification test results 2(a)/2(b) as applicable to be submitted to BHEL for review. BHEL will review the test results. Based on test results BHEL will decide for qualification of vendor.

3.0 Manufacturing and Testing Facilities:

3.1 Vendor must be having in house rolling/forging and heat treatment facility to manufacture rectangular bars of enquiry dimensions. Details of in house facilities for rolling/forging and heat treatment are to be submitted.

3.2 Vendor to furnish details of in house steel melting and refining facilities to manufacture raw material for further rolling/forging for turbine blade flats as per enquiry specification.

In case, steel melting facility is not available in house, vendor to inform their source of raw material with following details of their source – Experience for enquiry material grade with at least one mill test certificate of enquiry material grade, melting & refining facilities.

Electroslag re-melted steel is only acceptable.

3.3 Details of testing facilities as per the requirement of enquiry specification to be submitted with offer. In case of outsourcing of any test, vendor to agree to carry out testing at Government accredited labs only

Annexure-2 (Item Details)

M/S. OPEN TENDER

DUEDATE

08-06-2020

BHEL

HARIDWAR249403

Vendor Code

00001

INDIA

-

SL	MATERIAL CODE ITEM DESCRIPTION	QUANTITY	UNIT	LOTNO	LOT DELIVERY QTY SCHEDULE
----	-----------------------------------	----------	------	-------	------------------------------

1	HW1060379058 HEAT RESISTANT STEEL BARS FOR TURBINE BLADES, GRADE: X13CrMo CoVNbNB9-2-1 (FB2) - Rectangul ar (Flat)-standard (Does not i nclude Plate, Sheet & Strip) B ars - 89 X 44 mm SPEC: HW10679 REV: 00 SIZE: 89X44 DIM.: WXT	3600	KG	1	3600 30/06/20
---	--	------	----	---	---------------

2	HW1060379066 HEAT RESISTANT STEEL BARS FOR TURBINE BLADES, GRADE: X13CrMo CoVNbNB9-2-1 (FB2) - Rectangul ar (Flat)-standard (Does not i nclude Plate, Sheet & Strip) B ars -100 X 53 mm SPEC: HW10679 REV: 00 SIZE: 100X53 DIM.: WXT	3000	KG	1	3000 30/06/20
---	---	------	----	---	---------------

** IMPORTANT: This enquiry is 2 part tender. Techno-Commercial bid (Part-1) & Price Bids (Part-2) should be submitted in separate envelopes. These two envelopes should be submitted in a common sealed envelope. Techno-Commercial Bid shall contain detailed Technical Specification, Drawings Technical documents, Catalogues, taxes & duties, payment terms, delivery period, Validity of offer, Replica of Price Bid (Copy of price bid without price part) etc. The confirmation to the special terms & conditions must be submitted alongwith Techno-Commercial bid.

Special Instructions:
As per tender documents.

General Instructions:
Please visit our site www.bhelhwr.co.in for latest version of
General Instructions and Standard Terms & Conditions (GISTC) for Tender

MATERIAL CODE	QUANTITY	UNIT	LOTNO
ITEM DESCRIPTION			

Enquiries. All the bidders/vendors must ensure compliance of latest GISTC. Terms & Conditions printed overleaf of this Standard Tender enquiry format are null & void.

For this procurement, Public Procurement (Preference to Make in India), Order 2017 dated 15.06.2017 & 28.05.2018 and subsequent Orders issued by the respective Nodal Ministry shall be applicable even if issued after issue of this NIT but before finalization of contract / PO / WP against this NIT.

In the event of any Nodal Ministry prescribing higher or lower percentage of purchase preference and/ or local content in respect of this procurement, same shall be applicable.

Default purchase preference under Make in India order shall be 20% to suppliers with default minimum local content of 50% for all items / works / services.

For further details, please refer latest version of GISTC.

Procurements where the Estimated value to be procured is less than Rs. 5 lakhs shall be exempted from Public Procurement (Preference to Make in India), Order 2017 dated 15.06.2017 & 28.05.2018

VARDHMAN JAIN

Dy Mgr/PPX-T

ANNEXURE -3



BHARAT HEAVY ELECTRICALS LIMITED

HEEP-HARIDWAR, UTTARAKHAND (249403)

General Instructions and Standard Terms & Conditions for bidding against Tender Enquiry (GISTC)

For Foreign Bidders (Version April-2019,Rev: 04)

Table of Contents

1. GENERAL.....	1
2. ORIGIN OF QUOTATION.....	1
3. SUBMISSION OF TENDER.....	1
4. TENDER OPENING.....	2
5. SPECIFICATION, DRAWINGS & STANDARD.....	3
6. PRICE SCHEDULE.....	3
7. REVERSE AUCTION.....	4
8. DELIVERY TERMS.....	4
9. PENALTY FOR LATE DELIVERY.....	5
10. PAYMENT TERMS.....	6
11. BANK GUARANTEE.....	7
12. GUARANTEE / WARRANTY AND CORRESPONDING REPAIRS / REPLACEMENT OF GOODS.....	7
13. QUALITY REQUIREMENT.....	7
14. VALIDITY.....	7
15. RIGHT OF ACCEPTANCE.....	7
16. TRANSIT INSURANCE.....	8
17. PHYTOSANITARY CERTIFICATE.....	8
18. RISK PURCHASE.....	8
19. FORCE MAJEURE CLAUSE.....	8
20. NON-DISCLOSURE AGREEMENT.....	9
21. SETTLEMENT OF DISPUTES/ARBITRATION.....	9
22. INFORMATION TO THE BIDDERS.....	10
23. MAKE IN INDIA (GOVT-NOTIFICATION).....	10
24. NOTE.....	11

1. GENERAL.

These general terms & conditions shall apply to all the Tender Enquiries, notice inviting tenders, request for quotations concerning the supply of goods and / or rendering of services to Bharat Heavy Electricals Ltd., HEEP, Haridwar (hereinafter referred to as BHEL or the Purchaser). In case of placement of order these conditions will become part of purchase order until unless the deviations are specifically agreed by BHEL.

2. ORIGIN OF QUOTATION.

- The quotation should preferably be from the principal bidder. However tender specific authorized registered dealer / agent can also submit the bid on their behalf, failing which the quotation is liable to be ignored. BHEL prefers to deal directly with the principal manufacturers.
- An agent cannot quote on behalf of more than one principal in the same Tender Enquiry.

3. SUBMISSION OF TENDER.

- Bid/Quotation must be enclosed in sealed cover on which tender enquiry number and the due date MUST BE written and be invariably sent under REGISTERED POST / SPEED POST / COURIER/Dropped in the Tender Box: addressed as follows: -

Quotation Against Enquiry No. _____ Dated: _____

Due on: _____

To,
THE HEAD OF MATERIALS MANAGEMENT,
Heavy Electrical Equipment Plant,
Bharat Heavy Electricals Limited,
HARIDWAR-249403 (Uttarakhand), INDIA.

- TENDER BOX is located at TENDER ROOM, Room No. - 415, 4th Floor, Main Admin. Building, BHEL-HEEP, Haridwar.

Quotations / Bids not in accordance with General Instructions and Standard Terms & Conditions are likely to be ignored.



BHARAT HEAVY ELECTRICALS LIMITED

HEEP-HARIDWAR, UTTARAKHAND (249403)

General Instructions and Standard Terms & Conditions for bidding against Tender Enquiry (GISTC)
For Foreign Bidders (Version April-2019,Rev: 04)

- c) In case of Three / Two Part Bid, technical bid containing technical offer, duly signed; and un-priced copy of the Price Bid should be kept in one envelope. Price Bid containing only the price should be kept in a separate envelope. All envelopes indicating Part-1 or Part-2 or Part-3 as the case may be to be put in a bigger envelope. Please note that un-priced bid should be the exact replica of price bid but without prices.
- d) The bid / quotation must be posted before due date, keeping allowance for postal transit time. Quotations sent by any mode but not received in time will be ignored. Tender received through authorized E-mail is also acceptable. However, in time submission of tender in tender box shall be the responsibility of the bidder, sent through any mode. Documents submitted with the offer / bid shall be signed and stamped in each page by authorized representative of the bidder.
- e) Any additional documents submitted by supplier / bidder, during processing of registration application / tender or after placement of order shall not be accepted unless it is submitted with forwarding letter and duly signed and stamped.
- e) The bids of the bidders who are on the banned list and also the bids of the bidders, who engage the services of the banned firms, shall be rejected. The cutting / overwriting in the bid / offer must be duly attested by the signatories to the bid. The list of firms banned by BHEL is available on BHEL web site www.bhel.com.
- f) Being PMD vendor, if you are not quoting against this tender enquiry, please send your regret letter positively for our reference with valid reasons for not participating in the tender enquiry. Repeated lack of response on the part of bidder may lead to deletion of such PMD vendor from BHEL's approved vendor list.
- g) The bidders will submit Integrity Pact, duly signed by its authorized signatory, along with their bids wherever estimated tender value is Rs. 5 Crore or more.
- h) In case of open tender, the unregistered bidder shall submit inter alia duly filled-in Supplier Registration Form (SRF) along with the bid. Bidders can download the SRF from www.bhel.com
- i) BHEL reserves the right to award tendered quantities among more than one bidder (after acceptance of L1 price by the other bidders). BHEL can also consider awarding of part of the tendered quantity to other than L-1 bidder at **L1 counter offered rates**, if the quantity offered by the L-1 bidder is less than the quantity tendered for.
- j) BHEL may also reduce the Tender Quantity for offering it to Micro & Small Enterprise (MSE) Indian Vendors as per applicable Government of India rules whose prices are within 15% of L1 prices as per directives of Government of India.
- k) In case of e-Tendering (Online bidding through e portal), offline bid submitted in hard copy or in any other form by the vendor / supplier will not be accepted and will be rejected out rightly. Only e-portal bid will be accepted.

4. TENDER OPENING.

Tender opening is scheduled to start in the Tender Room at 2:00 PM, on the due date. Therefore, bid / quotations must reach this office / tender Box latest by 1:45 PM on due date. Only participating bidders are allowed to attend tender opening. **TENDERS RECEIVED AFTER THE SPECIFIED TIME OF THEIR 'SUBMISSION' WILL BE TREATED AS LATE TENDERS AND SHALL NOT BE CONSIDERED UNDER ANY CIRCUMSTANCES.** The bidders or their authorized representatives may be allowed to attend tender opening if duly authorized by their principals, through a tender specific letter on that particular day. General authorization letter is not acceptable.

Quotations / Bids not in accordance with General Instructions and Standard Terms & Conditions are likely to be ignored.



BHARAT HEAVY ELECTRICALS LIMITED

HEEP-HARIDWAR, UTTARAKHAND (249403)

General Instructions and Standard Terms & Conditions for bidding against Tender Enquiry (GISTC)
For Foreign Bidders (Version April-2019,Rev: 04)

Note: - Foreign bidders willing to attend the bid opening has to provide the requisite documents to the concerned Purchase executives for arranging gate pass for them.

5. SPECIFICATION, DRAWINGS & STANDARD.

- a) Bidders must give their detailed specification in the quotation along with relevant technical literature / catalogue etc. against the tender enquiry.
- b) The Bid should be accompanied with relevant copies of catalogues, drawings or specification as per tender enquiry. If these documents are not furnished, the offer is liable to be rejected.
- c) Wherever national / international (N/IN) standards are referred, the latest N/IN standards are to be followed. Mention year & date of standard revision that shall be followed for the supply.
- d) All Drawings and Standards are proprietary of BHEL. It must not be used in anyway detrimental to the interest of the company.

6. PRICE SCHEDULE.

- a) Kindly quote your prices in figures and words both. In case of any discrepancy in value, the prices quoted in words shall be considered for evaluation and establishing L1 status.
- b) Prices quoted should not be more than the prices quoted to any other BHEL units / offices / divisions. Vendor to submit copy of latest Purchase Order placed by any unit of BHEL for similar items in the technical bid. In case no order has been placed on such items, specific confirmation that no order has been placed on such items should be provided.
- c) Bidders need to quote their prices on CFR any sea port in Mumbai or FCA basis to the named airport in Euro/USD/JPY/UK Pound/SF/Singapore Dollar or any other Internationally freely tradable currency only. The name of the currency should be clearly indicated in your bids.

- d) In case the vendor quotes the prices on CFR basis and BHEL accepts the delivery term on CFR, 0.25 % (of CFR Value) towards port handling charges & 1.5 % (of CFR Value) towards inland freight or actual freight charges as per BHEL freight rate contract whichever is higher, shall be loaded in the prices for ascertaining the landed cost to decide the comparative status of the prices.
- e) However, if BHEL agrees to accept the FOB delivery terms, the FOB prices shall be loaded 2.0% (of FOB Value) towards sea freight, 0.25% (of FOB Value) towards port handling charges & 1.5% (of FOB value) towards inland freight for ascertaining the landed cost to decide the comparative status of the prices.
- f) **Basis of Evaluation for Bid / Quotation in foreign currency:**
 1. Currency exchange rate (TT selling rates of SBI) for evaluation of the bid / quotation received in foreign currency will be as follows:
 2. Single part bid – Date of tender opening.
 3. Two / Three-part bid – Date of part 1 opening.
 4. Reverse auction – Date of part-1 opening.

Note: - Financial evaluation of L1, L2 ----- status will be on the basis of Landed Cost to BHEL.

g) Evaluation of Indian Agents Commission:

1. BHEL prefers to deal directly with foreign bidder, wherever required, for procurement of Goods. However, if the Foreign Principal desires to avail services of an Indian Agent then the Principal should ensure compliance to applicable guidelines.
2. The FOB / CIF price quoted will be deemed to be inclusive of Indian Agency commission. Agency commission if payable shall be converted to Indian Rupees at TT buying rates of exchange ruling on tender opening date which shall not be subjected to any further exchange rate variation, as disclosed by the bidder in his quoted FOB / CIF price will be paid in Indian Rupees on receipt & acceptance of Materials or it's installation at destination, as the case may be. The lower of the TT buying rate prevailing on the date of

Quotations / Bids not in accordance with General Instructions and Standard Terms & Conditions are likely to be ignored.



BHARAT HEAVY ELECTRICALS LIMITED

HEEP-HARIDWAR, UTTARAKHAND (249403)

General Instructions and Standard Terms & Conditions for bidding against Tender Enquiry (GISTC)
For Foreign Bidders (Version April-2019,Rev: 04)

technical bid opening shall be considered for computation of Agency commission.

3. In a tender either the Indian Agent on behalf of Principal / OEM or the Principal / OEM itself can bid, but both cannot bid simultaneously for same item / product in the same Tender. If both OEM and its authorized agent submit their bids separately in that case only the offer of OEM can be considered as an exception.

h) While submitting your bids please clearly indicate:

1. Expected weight of goods (lots wise).
2. The size of packed goods.
3. Whether the goods can be dispatched in containers?
4. Port of Loading.
5. Port of Discharge.

7. REVERSE AUCTION.

- a) BHEL reserves the right to go for Reverse Auction (RA) instead of opening the sealed envelope price bid, submitted by the bidder. This will be decided after Techno-Commercial Evaluation. All bidders to give their acceptance for participation in RA. Non-acceptance to participate in RA may result in non-consideration of their bids, in case BHEL decides for RA. Detailed guidelines available at our site www.bhel.com
- b) In case BHEL decides to go for Reverse Auction, only those bidders who have given their acceptance to participate in RA will be allowed to participate in the Reverse Auction. Those bidders who have given their acceptance to participate in Reverse Auction will have to necessarily submit 'online sealed bid' in the Reverse Auction. Non-Submission of 'online sealed bid' by the bidder will be considered as tampering of the tender process and will invite action by BHEL as per extant guidelines in vogue.

8. DELIVERY TERMS.

- a) Goods shall be dispatched by sea, unless stated otherwise in the tender enquiry or purchase order.
- b) Specifically confirm your agreement to change the mode by Air at BHEL's request as per mutually agreed terms even after placement of Purchase Orders.
- c) The Trans-shipment is not permissible in case of Break Bulk Cargo. In rest of the case Trans-shipment condition in BHEL purchase order / letter of credit will be as per Uniform Custom and Practice for documentary credits, UCP 600 of International Standard Bank proceed re-issued by International chamber of Commerce (ICC).
- d) Any demurrage / Godown Rent payable to the Port Authorities due to any delay attributed by the supplier will be recovered from supplier's account.
- e) A certificate of origin (COO) sanctioned in country of origin from chamber of commerce of the manufacturing country is to be provided mandatorily. However, a certificate of origin (COO) from the countries under the restricted list of Govt. of India will not be acceptable.
- f) For reasons of delay in receipt of documents from suppliers or due to the same being found to be incomplete, and / or faulty, the suppliers shall be responsible to reimburse in all demurrages / wharfages, if any paid by BHEL (for stated reasons).
- g) Load port charges shall be settled by the supplier and not be passed on to BHEL in form of destination charges.
- h) In the event of bidder offering CFR delivery terms for delivery in FCL (Full Container Load), the bidder shall provide 21 days' time free of detention for General Purchase Container / High Cube Container and 14 days for the other types from the date of delivery at delivery port. Wherever the detention free period offered is less than the above specified period, the consequential cost at port of clearance

Quotations / Bids not in accordance with General Instructions and Standard Terms & Conditions are likely to be ignored.



BHARAT HEAVY ELECTRICALS LIMITED

HEEP-HARIDWAR, UTTARAKHAND (249403)

General Instructions and Standard Terms & Conditions for bidding against Tender Enquiry (GISTC)
For Foreign Bidders (Version April-2019,Rev: 04)

shall be to the account of the bidder. Number of detention free days must be mentioned on Bill of Lading (BL).

- i) In case of CFR delivery, Port congestion charges or any additional charges claimed by shipping line till delivery at destination port shall be to the bidder's account.
- j) The shipping line should be ready to move the containers to consignees nominated CFS (Container Freight Station) yard and Indian agent of shipping line should issue Cargo Arrival Notice (CAN) 7 days in advance for filing the IGM (Import General Manifest) at discharge port.
- k) In case of CFR contract, bidder to supply the material through a Certified Sea worthy vessel.
- l) **The invoices being issued by shipping lines must be in the name of BHEL. Any loss in GST due to submission of discrepant document will be recovered from supplier / vendor.**
- m) While booking the shipment, bidder to also finalize **destination charges** and the same should appear over BL or agreed tariff to be provided to BHEL before arrival of shipment.
- n) If cargo is stuffed in container, then the same should be allowed to be moved to CFS of importers choice without any additional charges.
- o) NNDs (Non Negotiable Documents) (preferably with OBLs) should be sent to BHEL as detailed in para "p" (below), at least 7 days in advance i.e. 7 days before the arrival of vessel so as to enable BHEL to move the containers to JWC CFS.
- p) **Information related to OBL / AWB Documents:**
 - I. Consignee name and address should be same as mentioned in the Purchase order.
 - II. Notify party: Name and address will be as follows :(For discharge port Mumbai or Nhava Sheva)

Bharat Heavy Electricals Limited

14th Floor World Trade Centre-1, Cuffe Parade, Colaba, Mumbai -400005

Email: msseahwr@bhel.in & ppximx@bhelh.in (in case of Sea Shipments)

Email: msair@bhel.in and ppximx@bhelh.in (in Case of Air shipments)

For latest updating please refer our web site:

www.bhelhwr.co.in

- III. OBL should clearly mention the Indian agent address and contact details.
- IV. OBL should be issued as per UCP 600.
- V. In case of shipments other than FOB, OBL should mention the container detention free period.
- VI. In case of placement of an Order, BHEL requests bidder to supply one Original Bill of Lading / AWB directly to BHEL-Mumbai office (Address at Para "p-II") with other non-negotiable documents to ensure timely clearance of goods. The other Original Bill of Ladings (BL) may be routed through bank based on the other agreed terms and conditions of purchase order.

9. PENALTY FOR LATE DELIVERY.

a) Where items of Purchase Order are independently usable.

Penalty for Late Deliveries shall be applicable @0.5% per week or part thereof on the value of respective delayed supplies subject to a maximum of 10% of the value of respective delayed supplies. Value of delayed supplies will mean the Gross Value payable to the vendor (Before LD) against such supplies excluding taxes and duties.

b) Where the total items are required for a main equipment and items are interdependent.

Penalty for Late Deliveries shall be applicable @0.5% per week or part thereof on total value of Purchase Order subject to maximum of 10% of the total value of Purchase Order. Purchase Order value for this purpose shall be the

Quotations / Bids not in accordance with General Instructions and Standard Terms & Conditions are likely to be ignored.



BHARAT HEAVY ELECTRICALS LIMITED

HEEP-HARIDWAR, UTTARAKHAND (249403)

General Instructions and Standard Terms & Conditions for bidding against Tender Enquiry (GISTC)
For Foreign Bidders (Version April-2019,Rev: 04)

Total Gross Value payable to the vendor (Before LD) excluding taxes and duties.

“In case of CFR shipment where BHEL accepts the date of inspection as the date of delivery for the purpose of penalty, the vendor has to ensure the shipment within 30 days for containerized cargo and 45 days maximum for Break bulk cargo from the date of inspection. Any delay, beyond this period, which is not attributable to BHEL shall be considered for application of penalty.”

“In case of FOB shipment, vendor has to intimate the readiness of cargo after inspection to BHEL nominated Freight forwarder minimum 15 days in advance for containerized cargo and 30 days in advance for Break bulk cargo before the FOB delivery date. The delay in shipment due to late intimation to BHEL nominated freight forwarder and not attributable to BHEL will be considered for application of penalty”.

- c) Bidders are requested to quote the best delivery meeting the delivery requirements. BHEL reserves the right to reject the offers not meeting BHEL's delivery requirement.
- d) Commencement of delivery period shall be reckoned from the date of PO / LOI or any other agreed milestone.
- e) Bidder shall deliver the goods in the manner and schedule agreed under the terms and conditions of Purchase order.
- f) The delivery date for penalty purpose will be the Bill of Lading Date/Air way bill.

10. PAYMENT TERMS.

- a) BHEL's standard payment term is Payment after Receipt and Acceptance of Material / Item at HEEP, BHEL-Store or at desired destination unless otherwise specified in Special Terms attached to the tender enquiry.

- b) BHEL reserves the right to accept or reject the offer of the bidder who quotes the payment term other than BHEL's standard payment term.
- c) Where the payments are through bank, the documents may be presented for negotiation through BHEL designated banks which will be specified in Purchase order. Documents should be submitted within 5 days of vessel sailing and receipt of OBL from shipping line.
- d) In case BHEL agrees for payment through LC, the same shall be irrevocable, unconfirmed and will be opened 30 days prior to the scheduled delivery and will be valid for a period of 60 days.
- e) In case of payment after receipt and acceptance of material, 100% payment will be made within 75 days from the date of invoice subject to submission of non-discrepant documents within 15 days of supply as per terms and conditions of Purchase Order. In case any discrepancy found in the documents, BHEL will notify the same to vendor within 7 days of receipt. Vendor has to clear all the discrepancies in one go within 7 days thereafter else the payment may get delayed.

The loading criteria for the different payment terms shall be as under;

Payment Terms	Days of Loading
After Receipt & Acceptance of material within 75 days of supply.	No Loading
Against Delivery at BHEL-Stores Haridwar.	45
Against documents through bank (CAD):	45
Letter of Credit (LC)	120
Usance LC	No Loading if usance period is > 120 Days.
	Loading of days difference i.e difference between 120 days and usance period if the usance period is < 120 days.
Advance	Delivery Period + 120 Days -Advance Payment Days

Quotations / Bids not in accordance with General Instructions and Standard Terms & Conditions are likely to be ignored.



BHARAT HEAVY ELECTRICALS LIMITED

HEEP-HARIDWAR, UTTARAKHAND (249403)

General Instructions and Standard Terms & Conditions for bidding against Tender Enquiry (GISTC)
For Foreign Bidders (Version April-2019,Rev: 04)

11. BANK GUARANTEE.

In case the bank guarantees are required to be deposited towards security deposit / performance guarantee or for any other purpose as per the terms of this tender enquiry, such bank guarantees of the requisite value in the denominated currency of the purchase order should be from one of the Indian branch of BHEL consortium banks and the bank guarantee should be in the proforma as prescribed by BHEL. The proforma of bank guarantee and the list of consortium banks are displayed at BHEL website www.bhelhwr.co.in. However, in case the bank guarantee is not from BHEL consortium banks, then the bidder has to get the bank guarantee confirmed from one of the Indian branch of BHEL consortium banks and the bank charges for such confirmation will be borne by the bidder.

12. GUARANTEE / WARRANTY AND CORRESPONDING REPAIRS / REPLACEMENT OF GOODS.

- a) Goods shall comply with the specifications for material, workmanship and performance. Unless otherwise specified, the warranty shall be for a period of 18 months from the date of receipt. If the delivery is found non-compliant during the warranty period, leading to rejection, the Seller shall arrange free replacement / repair of goods, within one month from the date of intimation or any mutually agreed period. The rejected goods shall be taken away by the Seller at his cost and replaced on Delivered Duty Paid (DDP) (FOR - BHEL Stores / designated destination basis) within such period. In the event of the Seller's failure to comply, Purchaser may take action as appropriate, including Repair / Replenish rejected goods & disposal of rejections, at the risk & cost of the Seller. In case the defects attributable to Seller are detected during processing of the goods at BHEL or at our subcontractor's works, the Seller shall be responsible for free replacement / repair of the goods as required by BHEL.
- b) In case the material is rejected, then date of replacement will be considered as the actual date of delivery.

- c) The bidder shall have to pay 5% incidental charges while taking back supplied material if it is found rejected on receipt. The rejected material shall be sent back only after receipt of replacement / submission of BG/refund of amount paid.

13. QUALITY REQUIREMENT.

Your bid/quotation should have specific confirmation regarding meeting all our quality requirements such as. (i) Test Certificate (TC), (ii) Guarantee Certificate (GC) / Warranty Certificate (WC), (iii) Quality Plan (QP) (if applicable); and (iv) Pre-Dispatch Inspection at your works (if applicable).

14. VALIDITY.

The quotation should be valid for a minimum period of 90 days effective from the date of opening of tender, unless otherwise specified in the tender enquiry.

15. RIGHT OF ACCEPTANCE.

- a) **BHARAT HEAVY ELECTRICALS LIMITED HARIDWAR** reserves the right to reject any or all the bids / quotations without assigning any reason thereof. BHEL also reserves the right to increase or decrease the tendered quantities. Bidders should be prepared to accept order for reduced quantity without any extra charges.
- b) Any discount / revised offer / bids submitted by a bidder on its own shall be considered, provided it is received on or before the due date and time of offer / bid submission (Part-1). Conditional discounts shall not be considered for evaluation of tenders.
- c) Unsolicited discounts / revised offers / bids given after Part-1 bid opening shall not be accepted. No change in price will be permitted within the validity period asked for in the tender enquiry.

Quotations / Bids not in accordance with General Instructions and Standard Terms & Conditions are likely to be ignored.



BHARAT HEAVY ELECTRICALS LIMITED

HEEP-HARIDWAR, UTTARAKHAND (249403)

General Instructions and Standard Terms & Conditions for bidding against Tender Enquiry (GISTC)
For Foreign Bidders (Version April-2019,Rev: 04)

- d) In case of changes in scope and / or technical specification and / or commercial terms & conditions having price implication, techno-commercially acceptable bidders shall be asked by BHEL to submit the impact of such changes on their price bids. In case a bidder opts to submit revised price bid instead of impact called for, then latest price bid shall prevail. However, in both situations, original price bid will be necessarily opened.
- e) The bidder whose bid is technically not accepted will be informed & EMD wherever submitted shall be returned after finalization of contract. EMD shall be forfeited in the event of bidder opting out after tender opening.
- f) BHEL reserves the right to short close the existing Purchase Order / Rate Contract / Work Order or any extension thereof at any stage.

16. TRANSIT INSURANCE.

- a) Transit Insurance will be covered by BHEL under its open Marine Insurance Policy. Seller shall inform dispatch particulars (Purchase Order, RR/GR/BL/ AWB, Invoice value etc.) to Finance department (Store bill Section), BHEL Ranipur Haridwar (Uttarakhand -India) with value of consignment to the Purchaser within 07 days of dispatch for BHEL to arrange insurance coverage in its policy. Failure on the part of seller to inform dispatch particulars will make him liable to pay for any transit damages / losses suffered by the Purchaser.
- b) If Quoted Prices are inclusive of transit insurance, no weightage shall be given while evaluating the bids for Cost of Insurance, being in BHEL Scope.

17. PHYTOSANITARY CERTIFICATE:

- a) As per the Indian Law, all consignments being imported into India by air / sea require a phytosanitary certificate from the country of origin-if articles have been packed with wooden packaging materials. This is mandatory. Please confirm in

your offer / dispatch documents that the required phytosanitary certificate will be submitted.

- b) Packaging material means any kind of material of plant origin used for packing which include hay, straw wood shavings, wood chips, saw dust, wood waste, wooden pallets, dunnage mats, wooden packages, coir pith, peat or sphagnum moss etc.

18. RISK PURCHASE.

In case of abnormal delays (beyond the maximum late delivery period as per Penalty clause) in supplies / defective supplies or non-fulfillment of any other terms and conditions given in Purchase Order, BHEL may cancel the Purchase Order in full or part thereof, and may also make the purchase of such material from elsewhere / alternative source at the risk and cost of the supplier. BHEL will take all reasonable steps to get the material from alternate source at optimum cost. If bidder does not agree to the above Risk Purchase Clause, BHEL reserves the right to reject the offer. In case for compelling reasons BHEL accepts the offer without acceptance of this clause by the bidder and in the eventuality of Risk Purchase, appropriate action will be taken as per BHEL extant rules. This will be without prejudice to any other right of BHEL under the contract.

19. FORCE MAJEURE CLAUSE.

Notwithstanding any other thing contained anywhere else in the contract or PO (Purchase Order), In case the discharge of obligation under the contract by either party is impeded or made unreasonably onerous, neither party shall be considered in breach of the contract to the extent that performance of their respective obligation is prevented by an event of Force Majeure that arises after the effective date (PO date).

In the above clause, Force Majeure means an event beyond the control of the parties to the contract which prevents a party from complying with any obligation of the contract including but not limited to:

Quotations / Bids not in accordance with General Instructions and Standard Terms & Conditions are likely to be ignored.



BHARAT HEAVY ELECTRICALS LIMITED

HEEP-HARIDWAR, UTTARAKHAND (249403)

General Instructions and Standard Terms & Conditions for bidding against Tender Enquiry (GISTC)
For Foreign Bidders (Version April-2019,Rev: 04)

- a) Act of God (Such as but not limited to earthquake, drought, tidal waves, floods etc.).
- b) War (whether war be declared or not), Hostilities Invasion, Act of foreign enemy etc.
- c) Rebellion, revolution, insurrection, civil war etc.
- d) Contamination of Radio Activity from any nuclear fuel or from any other nuclear waste or any other hazardous materials.
- e) Riots, commotions, strike unless restricted to the employees of supplier.
- f) Acts of terrorism.
- g) Other unforeseeable circumstances beyond the control of the parties and which the affected party cannot avoid even by using its best efforts.
- h) Cancellation of contract by customer.
- i) Change in law/ government. Regulation making the performance impossible.

The party claiming to be affected by force majeure shall notify the other party in writing immediately without delay on the intervention and on the cessation of such circumstances.

Irrespective of any extension of time, if an event of force majeure occurs and its effect continues for more than 180 days the affected party shall have right to cancel the contract.

As soon as reasonably practicable following the date of commencement of a Force Majeure Event, and within a reasonable time following the date of termination of a Force Majeure Event, either Party invoking it shall submit to the other Party reasonable proof of the nature of the Force Majeure Event and of its effect upon the performance of the Party's obligations under this Agreement.

The party shall, and shall ensure that its Subcontractors shall, at all times take all reasonable steps within their respective powers and consistent with Good Operating Practices (but without incurring unreasonable additional costs) to:

- a) Prevent Force Majeure Events affecting the performance of the party's obligations under this Agreement;
- b) mitigate the effect of any Force Majeure Event; and
- c) Comply with its obligations under this Agreement.

If the war like situation has developed in a country where a seller's works is located in the P.O. or there is political instability and Indian Embassy located in that country forbids or advises for not having any business dealing with the sellers located in such zone / region/ country, then BHEL reserves the right to cancel the order.

20. NON-DISCLOSURE AGREEMENT.

All Drawing and Technical Documents relating to the product or it's manufacture submitted by one party to the other, prior or subsequent to the formation of contract, shall remain property of the submitting party. Drawing, technical documents or other technical information received by one party, shall not without the consent of the other party, be used for any other purpose than that, for which they were provided. Such technical information shall not without the consent of the submitting party, otherwise be used or copied, reproduced, transmitted or communicated to a third party. Patterns supplied by BHEL will remain BHEL's property which shall be returned by the bidder on demand to BHEL. Bidder shall in no way share or use such intellectual property of BHEL to promote his own business with others. BHEL reserves the right to claim damages from the bidder, or take appropriate penal action as deemed fit against the bidder, for any infringement of the provisions contained herein.

21. SETTLEMENT OF DISPUTES/ARBITRATION.

Any dispute/difference arising out of or in connection with this contract, including any question regarding its existence, validity or termination, shall be referred to and finally resolved by arbitration under the Arbitration and Conciliation Act, 1996 of India by a Sole Arbitrator to be appointed with mutual consent of the parties. Such Sole Arbitrator shall be either a retired judge of Supreme Court or High Court or District Court of India or some Advocate having practiced in Indian Courts. The seat or place of arbitration shall be New Delhi, India. The language to be used in the arbitration shall be English. The governing law of the contract shall be the substantive law of India. In case the parties fail to agree on the appointment of arbitrator within 2 months of the notice invoking arbitration by one party, then the

Quotations / Bids not in accordance with General Instructions and Standard Terms & Conditions are likely to be ignored.



BHARAT HEAVY ELECTRICALS LIMITED

HEEP-HARIDWAR, UTTARAKHAND (249403)

General Instructions and Standard Terms & Conditions for bidding against Tender Enquiry (GISTC)
For Foreign Bidders (Version April-2019,Rev: 04)

arbitrator shall be appointed in accordance with the Arbitration and Conciliation Act, 1996 of India.

JURIDICTION: The courts of New Delhi, India, shall have exclusive jurisdiction.

22. INFORMATION TO THE BIDDERS.

- a) Purchase related information is available at our Business-to-Business (B2B) Portal available on our website www.bhelhwr.co.in. The user ID & password can be obtained by sending a request to concerned purchase executives.
- b) Intimate your change in mail address or communication address or changes, if any, by email to AGM(SDX/MM) giving your bidder Code.
- c) Please resolve your rejections and unexecuted overdue purchase order immediately which are posted at our B2B Portal, which can be visited through our site www.bhelhwr.co.in.
- d) Copy of this Tender Enquiry is being sent through the post/ Courier / E-mail or by any existing means.
- e) Invoice description and Unit of measurement should be strictly in accordance with Purchase order.
- f) Unit of measurement for dimension and weight should be in metric system only.

23. MAKE IN INDIA (GOVT-NOTIFICATION).

- A. This tender enquiry shall be governed by notification no. P-45021/2/2017-PP (BE-II) dated 28.05.2018 of government of INDIA. Accordingly, the minimum local content, the margin of purchase preference and the procedure for preference to make in INDIA shall be adhered.
- B. Default purchase preference shall be 20% to local suppliers with default minimum local content of 50% for all items / works / services unless any of the Nodal Ministry has prescribed, or prescribe in future lower or higher percentage of purchase preference and/or local content in respect of any items / works / services in which case the purchase preference and/ or local content for that

particular items / works / services shall be as prescribed by the Nodal Ministry.

- C. Vendor to specifically confirm if they are local supplier or not as per above mentioned notification. Accordingly, the local supplier at the time of tender, bidding or solicitation shall be required to provide self-certification that the item offered meets the minimum local content and shall give details of the location(s) at which the local value addition is made.

'Local Supplier' means a supplier or service provider whose product or service offered for procurement meets the minimum local content. 'Local Content' means the amount of value added in India, which shall, unless otherwise prescribed, be the total value of the item procured (excluding net domestic indirect taxes) minus the value of imported content in the item (including all custom duties) as a proportion of the total value, in percent.

- D. In cases of Procurement for a Value in Excess of Rs. 10 Crores, the Local Supplier shall be required to provide a Certificate from the Statutory Auditor or Cost Auditor of the Company (in the case of companies) or from a practicing Cost Accountant or practicing Chartered Accountant (in respect of suppliers other than companies) giving the percentage of Local Content.
- E. **Requirement of Purchase Preference:** Purchase preference shall be given to local suppliers in all procurements undertaken in the manner specified hereunder-
 - a) "In Procurement of Goods, Services or Works in respect of which the Nodal Ministry has communicated that there is sufficient local capacity and local competition, and where the estimated value of procurement is Rs. 50 lakhs or less, only local suppliers shall be eligible. If the estimated value of procurement of such goods or services or works is more than Rs. 50 lakhs, the provisions of below sub-paragraph b or c, as the case may be, shall be apply".
 - b) "In the procurements of goods or work which are not covered by above paragraph a and which are divisible in nature, the following procedure shall be followed";
 - i) Among all qualified bids, the lowest bid will be termed as L1. If L1 is from a local supplier, the contract for full quantity will be awarded to L1.

Quotations / Bids not in accordance with General Instructions and Standard Terms & Conditions are likely to be ignored.



BHARAT HEAVY ELECTRICALS LIMITED

HEEP-HARIDWAR, UTTARAKHAND (249403)

General Instructions and Standard Terms & Conditions for bidding against Tender Enquiry (GISTC)
For Foreign Bidders (Version April-2019,Rev: 04)

- ii) If L1 bid is not from a local supplier, 50% of the order quantity shall be awarded to L1. Thereafter, the lowest bidder among the local suppliers will be invited to match the L1 price for the remaining 50% quantity subject to the local suppliers quoted price falling within the margin of purchase preference, and contract for that quantity shall be awarded to such local supplier subject to matching the L1 price. In case such lowest eligible local supplier fails to match the L1 price or accepts less than the offered quantity, the next higher local supplier within the margin of purchase preferences shall be invited to match the L1 price for remaining quantity and so on, and contract shall be awarded accordingly. In case some quantity is still left uncovered on local suppliers, then such balance quantity may also be ordered on the L1 bidder.
- c) "In procurements of goods or works not covered by subparagraph E.a) and which are not divisible and in procurement of services where the bid is evaluated on price alone, the following procedure shall be followed":-
- i) Among all qualified bids, the lowest bid will be termed as L1. If L1 is from a local supplier, the contract will be awarded to L1
- ii) If L1 is not from a local supplier, the lowest bidder among the local suppliers will be invited to match the L1 price subject to local supplier's quoted price, falling within the margin of purchase preference, and the contract shall be awarded to such local supplier subject to matching the L1 price.
- iii) In case such lowest eligible local supplier fails to match the L1 price, the local supplier with the next higher bid within the margin of purchase preference shall be invited to match the L1 price and so on and contract shall be awarded accordingly. In case none of the local suppliers within the margin of purchase preference matches the L1 price, then the contract may be awarded to the L1 bidder.

F. "For this procurement, Public Procurement (Preference to Make in India), Order 2017 dated 15.06.2017 & 28.05.2018 and subsequent Orders issued by the respective Nodal Ministry shall be applicable even if issued after issue of this NIT but before finalization of contract / PO / WP against this NIT.

In the event of any Nodal Ministry prescribing higher or lower percentage of purchase preference and/ or local content in respect of this procurement, same shall be applicable."

- G. Procurements where estimated value to be procured is less than Rs. 5 lakhs shall be exempted from GOI order No. P-45021/2/2017-PP (BE-II) dated 28.05.2018.
- H. "For procurement of Goods & Services which are divisible in nature, following shall be operated for **MSE bidders** under Public procurement (Preference to make in India), Order 2017 (revision) :-
- a. If L1 bid is not from local Supplier and price quoted by MSE bidder falls within the margin of Purchase preference (L1+15% for MSEs), then 25 % of total order quantity of respective item (rounded off to nearest number) shall be awarded to MSE bidder, subject to MSE bidder matching the L1 Price. Out of Remaining 75% quantity, distribution shall be operated as per below sub-clause (2) -
- b. If Local Supplier (Next to L1, other than MSE) quoted price falling within the Margin of Purchase Preference, and local supplier matches the L1 price, then 50% of remaining Quantity (after allocation of 25% to MSE) i.e. 37.5% shall be awarded to local supplier and 37.5% shall be awarded to Foreign bidder.

Note : L1 Price refers to lowest evaluated / landed cost to company.

For Further details, please refer GOI order no. P-45021 / 2 / 2017 - PP (BE-II) dated 28.05.2018.

24. NOTE.

- a) Special conditions of enquiry, if enclosed by BHEL, will supersede the respective standard/general terms of enquiry.
- b) Any other Standard terms and Conditions of the bidder attached/referred against the tender enquiry will be treated as null and void ab initio.
- c) In order to protect the commercial interests of BHEL, it becomes necessary to take action against suppliers / contractors by way of supervision of business dealings, who either fail to perform or are in default without any

Quotations / Bids not in accordance with General Instructions and Standard Terms & Conditions are likely to be ignored.



BHARAT HEAVY ELECTRICALS LIMITED

HEEP-HARIDWAR, UTTARAKHAND (249403)

General Instructions and Standard Terms & Conditions for bidding against Tender Enquiry (GISTC)
For Foreign Bidders (Version April-2019,Rev: 04)

reasonable cause, cause loss of business / money / reputation, indulged in malpractices, cheating, bribery, fraud or any other misconducts or formation of cartel so as to influence the bidding process or influence the price etc. Guide- lines for Suspension of Business Dealings with Suppliers / Contractors shall prevail over which is available at BHEL website <http://www.bhel.com>

d) The bidder along with its associate / collaborators / sub-contractors / sub-vendors / consultants / service providers shall strictly adhere to BHEL Fraud Prevention Policy displayed on BHEL website <http://www.bhel.com> and shall immediately bring to the notice of BHEL-Management about any fraud or suspected fraud as soon as it comes to their notice.

e) "BHEL shall recover the amount of compensation paid to victim(s) by BHEL towards loss of life / permanent disability due to an accident which is attributable to the negligence of contractor, agency or firm or any of its employees as detailed below;

1. **Victim:** Any person who suffers permanent disablement or dies in an accident as defined below.

2. **Accident:** Any death or permanent disability resulting solely and directly from any unintended and unforeseen injurious occurrence caused during the manufacturing / operation and works incidental thereto at BHEL factories/ **offices and precincts** thereof , project execution , erection and commissioning, services, repairs and maintenance, trouble shooting, serving , overhaul, renovation and retrofitting , trial operation, performance guarantee testing undertaken by the company or during any works / during working at BHEL Units/ Offices/ townships and premises/ project sites.

3. **Compensation in respect of each of the victims:**

(i) In the event of death or **permanent disability** resulting from **Loss of both limbs:** Rs. 10,00,000/- (Rs. Ten Lakh).

(ii) In the event of **other permanent disability:** Rs. 7,00,000/- (Rs. Seven Lakh).

Permanent Disablement: A disablement that is classified as a permanent total disablement under the proviso to Section 2(l) of the Employees Compensation Act, 1923."

Quotations / Bids not in accordance with General Instructions and Standard Terms & Conditions are likely to be ignored.

ANNEXURE -3



BHARAT HEAVY ELECTRICALS LIMITED

HEEP-HARIDWAR, UTTARAKHAND (249403)

General Instructions and Standard Terms & Conditions for bidding against Tender Enquiry (GISTC)

For Indian Bidders (Version April-2019, Rev: 04)

Table of Contents

1. GENERAL	1
2. ORIGIN OF QUOTATION	1
3. SUBMISSION OF TENDER	1
4. TENDER OPENING	2
5. SPECIFICATION, DRAWINGS & STANDARD	2
6. PRICE SCHEDULE	3
7. REVERSE AUCTION	3
8. DELIVERY TERMS	4
9. PENALTY FOR LATE DELIVERY	4
10. PAYMENT TERMS	4
11. TAXES & DUTIES	5
12. BANK GUARANTEE	6
13. GUARANTEE / WARRANTY AND CORRESPONDING REPAIRS / REPLACEMENT OF GOODS	6
14. QUALITY REQUIREMENT	6
15. VALIDITY	6
16. RIGHT OF ACCEPTANCE	6
17. TRANSIT INSURANCE	7
18. RISK PURCHASE	7
19. FORCE MAJEURE CLAUSE	7
20. NON-DISCLOSURE AGREEMENT	8
21. SETTLEMENT OF DISPUTES / ARBITRATION	8
22. WHARFAGE / DEMURRAGE RESPONSIBILITY	8
23. CONDITIONS FOR AVAILING MICRO & SMALL ENTERPRISES (MSE'S) BENEFITS	8
24. INFORMATION TO THE BIDDERS	10
25. MAKE IN INDIA (GOVT-NOTIFICATION)	10
26. NOTE	11

1. GENERAL.

These general terms & conditions shall apply to all the Tender Enquiries, notice inviting tenders, request for quotations concerning the supply of goods and / or rendering of services to Bharat Heavy Electricals Ltd., HEEP, Haridwar (hereinafter referred to as BHEL or the Purchaser). In case of placement of order these conditions will become part of Purchase Order (P.O) until unless the deviations are specifically agreed by BHEL.

2. ORIGIN OF QUOTATION.

- The quotation should preferably be from the principal bidder. However tender specific authorized registered dealer/agent can also submit the bid on their behalf, failing which the quotation is liable to be ignored. BHEL prefers to deal directly with the principal manufacturers.
- An agent cannot quote on behalf of more than one principal in the same Tender Enquiry.

3. SUBMISSION OF TENDER.

- Bid / Quotation must be enclosed in sealed cover on which tender enquiry number and the due date MUST BE written and be invariably sent under REGISTERED POST / SPEED POST / COURIER / Dropped in the Tender Box: addressed as follows:
-

Quotation against Enquiry No. _____

Dated: _____

Due on: _____

To,

**THE HEAD OF MATERIALS MANAGEMENT,
Heavy Electrical Equipment Plant,
Bharat Heavy Electricals Limited,
HARIDWAR-249403 (Uttarakhand), INDIA.**

- TENDER ROOM is located at: Room No. - 415, 4th Floor, Main Admin. Building, BHEL-HEEP, Haridwar.

Quotations / Bids not in accordance with General Instructions and Standard Terms & Conditions are likely to be ignored.



BHARAT HEAVY ELECTRICALS LIMITED

HEEP-HARIDWAR, UTTARAKHAND (249403)

General Instructions and Standard Terms & Conditions for bidding against Tender Enquiry (GISTC)

For Indian Bidders (Version April-2019, Rev: 04)

- c) In case of Three / Two Part Bid, technical bid containing technical offer, duly signed and un-priced copy of the Price Bid should be kept in one envelope. Price Bid containing only the price should be kept in a separate envelope. All envelopes indicating Part-1 or Part-2 or Part-3 as the case may be to be put in a bigger envelope. Please note that un-priced bid should be the exact replica of price bid but without prices.
- d) The bid / quotation must be posted before due date, keeping allowance for postal transit time. Quotations sent by any mode but not received in time will be ignored. Tender received through authorized E-mail is also acceptable. However, in time submission of tender in tender box shall be the responsibility of the bidder, sent through any mode. Documents submitted with the offer / bid shall be signed and stamped in each page by authorized representative of the bidder.
- e) Any additional documents submitted by supplier / bidder, during processing of registration application / tender or after placement of order shall not be accepted unless it is submitted with forwarding letter and duly signed and stamped.
- f) The bids of the bidders who are on the banned list and also the bids of the bidders, who engage the services of the banned firms, shall be rejected. The cutting / overwriting in the bid / offer must be duly attested by the signatories to the bid. The list of firms banned by BHEL is available on BHEL web site www.bhel.com.
- g) Being PMD vendor, if you are not quoting against this tender enquiry, please send your regret letter positively for our reference with valid reasons for not participating in the tender enquiry. Repeated lack of response on the part of bidder may lead to deletion such PMD vendor from BHEL's approved vendor list.
- h) The bidders will submit Integrity Pact, duly signed by its authorized signatory, along with their bids wherever estimated tender value is Rs. 5 Crore or more.
- i) In case of open tender, the unregistered bidder shall submit inter alia duly filled-in Supplier Registration Form (SRF) along with the bid. Bidders can download the SRF from www.bhel.com
- j) BHEL reserves the right to award tendered quantities among more than one bidder (after acceptance of L1 price by the other bidders). BHEL can also consider awarding of part of the tendered quantity to other than L-1 bidder at **L1 counter offered rates**, if the quantity offered by the L-1 bidder is less than the quantity tendered for.
- k) In case of e-Tendering (Online bidding through e-portal), offline bid submitted in hard copy or in any other form by the vendor / supplier will not be accepted and will be rejected out rightly. Only e-portal bid will be accepted.

4. TENDER OPENING.

Tender opening is scheduled to start in the Tender Room at 2:00 PM, on the due date. Therefore, bid / quotations must reach this office / tender Box latest by 1:45 PM on due date. Only participating bidders are allowed to attend tender opening. **TENDERS RECEIVED AFTER THE SPECIFIED TIME OF THEIR 'SUBMISSION' WILL BE TREATED AS LATE TENDERS AND SHALL NOT BE CONSIDERED UNDER ANY CIRCUMSTANCES.** The bidders or their authorized representatives may be allowed to attend tender opening if duly authorized by their principals, through a tender specific letter on that particular day. General authorization letter is not acceptable.

Note: - Foreign bidders willing to attend the bid opening has to provide the requisite documents to the concerned Purchase executives for arranging gate pass for them.

5. SPECIFICATION, DRAWINGS & STANDARD.

- a) Bidders must give their detailed specification in the quotation along with relevant technical literature / catalogue etc. against the tender enquiry.



BHARAT HEAVY ELECTRICALS LIMITED

HEEP-HARIDWAR, UTTARAKHAND (249403)

General Instructions and Standard Terms & Conditions for bidding against Tender Enquiry (GISTC)

For Indian Bidders (Version April-2019, Rev: 04)

- b) The Bid should be accompanied with relevant copies of catalogues, drawings or specification as per tender enquiry. If these documents are not furnished, the offer is liable to be rejected.
- c) Wherever national / international (N/IN) standards are referred, the latest N/IN standards are to be followed. Mention year & date of standard revision that shall be followed for the supply.
- d) All Drawings and Standards are proprietary of BHEL. It must not be used in anyway detrimental to the interest of the company.

6. PRICE SCHEDULE.

- a) Kindly quote your prices in figures and words both. In case of any discrepancy in value, the prices quoted in words shall be considered for evaluation and establishing L1 status.
- b) Prices quoted should not be more than the prices quoted to any other BHEL units / offices / divisions. Vendor to submit copy of latest Purchase Order placed by any unit of BHEL for similar items in the technical bid. In case no order has been placed on such items, specific confirmation that no order has been placed on such items should be provided.
- c) Prices should be quoted on F.O.R. Destination basis. Transit insurance shall be arranged by BHEL and not to be included in the prices. The offers quoted on other than F.O.R destination basis may result in non-consideration of such bids.
- d) In case BHEL accepts the EX-Works prices, such offers will be loaded by 1.5% of EX-Works value towards freight or with actual freight charges as per BHEL freight rate contract whichever is higher.
- e) In case of Indigenous items covered by DGS & D Rate Contract, the bidders should submit latest valid copy of the rate contract along with bid / quotation
- f) Applicable **IGST / CGST / SGST** and any other statutory levy should be indicated separately and clearly in the bid / quotation.

- g) Bidders can dispatch goods through any Indian Bank Association approved transporters having their branch at HARIDWAR / destination. If material is dispatched through other than Indian Bank Association approved transporter, material to be delivered on door delivery BHEL Stores basis.
- h) In case of dispatch of material through any other unapproved transporter, payment shall be made only after receipt of material and any additional charges payable to the transporter shall be to the bidder's account.
- i) Any demurrage / godown rent payable to the transporter / or to godown's owner due to any delay attributed by the supplier shall be recovered from supplier's account.

NB: Financial evaluation of L1, L2Status will be on the basis of Landed Cost to BHEL.

7. REVERSE AUCTION.

- a) BHEL reserves the right to go for Reverse Auction (RA) instead of opening the sealed envelope price bid, submitted by the bidder. This will be decided after Techno-Commercial Evaluation. All bidders to give their acceptance for participation in RA. Non-acceptance to participate in RA may result in non-consideration of their bids, in case BHEL decides for RA. Detailed guidelines available at our site www.bhel.com
- b) In case BHEL decides to go for Reverse Auction, only those bidders who have given their acceptance to participate in RA will be allowed to participate in the Reverse Auction. Those bidders who have given their acceptance to participate in Reverse Auction will have to necessarily submit 'online sealed bid' in the Reverse Auction. Non-Submission of 'online sealed bid' by the bidder will be considered as tampering of the tender process and will invite action by BHEL as per extant guidelines in vogue.

Quotations / Bids not in accordance with General Instructions and Standard Terms & Conditions are likely to be ignored.



BHARAT HEAVY ELECTRICALS LIMITED

HEEP-HARIDWAR, UTTARAKHAND (249403)

General Instructions and Standard Terms & Conditions for bidding against Tender Enquiry (GISTC)

For Indian Bidders (Version April-2019, Rev: 04)

8. DELIVERY TERMS.

- a) Goods shall be delivered on 'FOR Destination' basis to the named destination unless otherwise called for in the tender enquiry.
- b) Loading on account of 3rd party inspection charges in case of Indian bidders shall be 0.20%.

9. PENALTY FOR LATE DELIVERY.

a) Where items of Purchase Order are independently usable.

Penalty for Late Deliveries shall be applicable @0.5% per week or part thereof on the value of respective delayed supplies subject to a maximum of 10% of the value of respective delayed supplies. Value of delayed supplies will mean the Gross Value payable to the vendor (Before LD) against such supplies excluding taxes and duties.

b) Where the total items are required for a main equipment and items are interdependent.

Penalty for Late Deliveries shall be applicable @0.5% per week or part thereof on total value of Purchase Order subject to maximum of 10% of the total value of Purchase Order. Purchase Order value for this purpose shall be the Total Gross Value payable to the vendor (Before LD) excluding taxes and duties.

- c) Bidders are requested to quote the best delivery meeting the delivery requirements. BHEL reserves the right to reject the offers not meeting BHEL's delivery requirement.
- d) Commencement of delivery period shall be reckoned from the date of PO / LOI or any other agreed milestone.
- e) Bidder shall deliver the goods in the manner and schedule agreed under the terms and conditions of Purchase order.
- f) **DELIVERY IN CASE OF REJECTION:** In case the material is rejected, then date of replacement will be considered as the actual date of delivery.

g) **DELIVERY AGAINST BANK DOCUMENTS:** In case payment terms quoted by bidder are documents through bank, and the delivery terms being "FOR Haridwar / FOR Transporter Go-down" then date of delivery will be date of intimation by transporter / bidder of delivery of material at Haridwar for the penalty purpose.

g) Where the payments are through bank, the documents may be presented for negotiation to BHEL authorized / nominated bank.

10. PAYMENT TERMS.

a) BHEL's standard payment term is Payment after receipt and acceptance of materials / items at HEEP, BHEL-Store or at desired destination unless otherwise specified in Special Terms attached to the tender enquiry.

b) BHEL reserves the right to accept or reject the offer of the bidder who quotes the payment term other than BHEL's standard payment term.

c) Loading on account of deviation in payment terms shall be done as per extant rules of BHEL-Haridwar.

d) 100% payment along with taxes, freight & insurance will be made after receipt and acceptance of material and within 75 days from the date of invoice subject to submission of non-discrepant documents within 15 days of supply as per terms and conditions of Purchase Order. In case any discrepancy found in the documents, BHEL will notify the same to vendor within 7 days of receipt. Vendor has to clear all the discrepancies in one go within 7 days thereafter else the payment of vendor may get delayed.

e) For MSEs (covered under MSME Act) which are registered and periodically renewed with BHEL, the payment will be made within 45 days or as prescribed in the relevant act.

f) Adherence to the above time schedule of payment is contingent upon Vendor complying with GST Rules w.r.t availment of Input Tax Credit by BHEL.

g) In case GST credit is delayed / denied to BHEL, due to non / delayed receipt of goods and / or tax invoice or expiry of the timeline prescribed in GST Law for availing such ITC, or any other reason not attributable to BHEL, GST amount shall be



BHARAT HEAVY ELECTRICALS LIMITED

HEEP-HARIDWAR, UTTARAKHAND (249403)

General Instructions and Standard Terms & Conditions for bidding against Tender Enquiry (GISTC)

For Indian Bidders (Version April-2019, Rev: 04)

recoverable from Vendor along with interest levied / leviable on BHEL.

h) The taxes and duties that are reimbursed would be the ones applicable as on the contractual Purchase order delivery date or the amount actually paid whichever is less.

i) **The loading criteria for the different payment terms shall be as under;**

Payment Terms	Days of Loading
After Receipt & Acceptance of material within 75 days of supply.	No Loading
Against Delivery at BHEL-Stores Haridwar.	45
Against documents through bank (CAD):	45
Letter of Credit (LC)	120
Usance LC	No Loading if usance period is > 120 Days.
	Loading of days' difference i.e. difference between 120 days and usance period if the usance period is < 75 days.
Advance	Delivery Period + 120 Days - Advance Payment Days.

11. TAXES & DUTIES.

a) The bidder to specify in their offer (part 1 bid) the category of their registration under GST like Registered, Unregistered and composite dealer.

b) The provisional GST registration number of Bharat Heavy Electrical Ltd, Heavy Electricals Equipment Plant, Ranipur, Haridwar is "05AAACB4146P1ZL" with state Code as "05" and State Name as "Uttarakhand".

c) Please quote our provisional GST registration number in all invoices raised for supply of goods and services under GST regime and also ensure filing of timely return and payment of tax and compliance of other applicable provisions on supplier under GST regime.

d) No GST will be reimbursed to unregistered or composite dealer. In the event, any GST is quoted by composite dealer,

the same shall be added to the cost of supply in evaluating the bid.

e) Since, input credit of GST will be available to BHEL-Haridwar only after correct filing of return and payment of applicable GST by supplier, reimbursement of GST shall be made by BHEL-Haridwar on matching of vendor inputs at GST portal, ensuring availability of input credit to BHEL Haridwar. Payment of GST will be made to vendor after matching of input credit and vendor to ensure submission of their invoices along with consent to accept payment of tax after such matching in all cases where bills are submitted directly to BHEL-Haridwar or through bank or under LC or through any other mode.

f) In the event of any disallowance of input credit or applicability of interest or any other financial liability arises on BHEL-Haridwar due to any default of supplier under GST, such implication shall be to supplier's account.

g) In the event of any change in the status of the vendor after the submission of the bid but before the supply, GST applicable at the time of supply or in the bid, based on the registration status of the vendor, whichever is lower shall be payable.

h) Where ever applicable If PAN (Permanent Account Number) of the recipient is not available, income tax is deductible either at the normal rate or at the rate of 20 percent, whichever is higher as per Section 206AA of Indian Income Tax Act 1961.

i) The bidder shall clearly indicate HSN (*Harmonised System Nomenclature*) / SAC (*Service Accounting Code*), its description and applicable rate of GST for each item in his techno-commercial bid.

j) Statutory Variation in Taxes & duties as applicable at the time of supply shall be payable. However, in the event of no change in law but bidder quoting certain tax structure in bid document which is lower than the applicable one, such amount shall be the maximum amount of tax that can be claimed by bidder.



BHARAT HEAVY ELECTRICALS LIMITED

HEEP-HARIDWAR, UTTARAKHAND (249403)

General Instructions and Standard Terms & Conditions for bidding against Tender Enquiry (GISTC)

For Indian Bidders (Version April-2019, Rev: 04)

k) IMPORTED GOODS OFFERED BY INDIAN BIDDERS AGAINST

DEALER INVOICE: Wherever the material being offered is imported, the bidder must quote the prices inclusive of IGST. The rate and value of IGST as included in the price must be indicated separately. In case quantum of IGST is not mentioned by the bidder the same will not be considered for evaluation. However, bidder will have to pass on the benefit of IGST to BHEL at the time supply.

- l) In case of directly dispatchable items to Customer's Site, BHEL-Haridwar will inform the GST registration number of the respective customer which must be mentioned on the vendor's invoice. Vendor to ensure availability of such information from BHEL-Haridwar before dispatch of any material. However, while filing GSTN-1, BHEL Haridwar GSTN number to be quoted.

Note: - Vendors must ensure compliance of all the applicable rules and procedure as envisaged in the GST Regime. Any loss to BHEL-Haridwar due to fault / non-compliance by the vendor will be to the vendor's account.

12. BANK GUARANTEE.

In case the bank guarantees are required to be deposited towards security deposit/performance guarantee or for any other purpose as per the terms of this tender enquiry, such bank guarantees of the requisite value in the denominated currency of the purchase order should be from one of the Indian branch of BHEL consortium banks and the bank guarantee should be in the proforma as prescribed by BHEL. The proforma of bank guarantee and the list of consortium banks are displayed at BHEL website www.bhelhwr.co.in. However, in case the bank guarantee is not from BHEL consortium banks, then the bidder has to get the bank guarantee confirmed from one of the Indian branch of BHEL consortium banks and the bank charges for such confirmation will be borne by the bidder.

13. GUARANTEE / WARRANTY AND CORRESPONDING REPAIRS / REPLACEMENT OF GOODS.

Goods shall comply with the specifications for material, workmanship and performance. Unless otherwise specified, the warranty shall be for a period of 18 months from the date of receipt. If the delivery is found non-compliant during the warranty period, leading to rejection, the Seller shall arrange free replacement / repair of goods, within one month from the date of intimation or any mutually agreed period. The rejected goods shall be taken away by the Seller at his cost and replaced on Delivered Duty Paid (DDP) (FOR - BHEL Stores / designated destination basis) within such period. In the event of the Seller's failure to comply, Purchaser may take action as appropriate, including Repair / Replenish rejected goods & disposal of rejections, at the risk & cost of the Seller. In case the defects attributable to Seller are detected during processing of the goods at BHEL or at our subcontractor's works, the Seller shall be responsible for free replacement / repair of the goods as required by BHEL.

- b) **RETURN OF REJECTED MATERIAL FOR REPLACEMENT:** The bidder shall have to pay 5% incidental charges while taking back supplied material if it is found rejected on receipt. The rejected material shall be sent back only after receipt of replacement / submission of BG / refund of amount paid.

14. QUALITY REQUIREMENT.

Your bid / quotation should have specific confirmation regarding meeting all our quality requirements such as. (i) Test Certificate (TC), (ii) Guarantee Certificate (GC) / Warranty Certificate (WC), (iii) Quality Plan (QP) (if applicable); and (iv) Pre-Dispatch Inspection at your works (if applicable).

15. VALIDITY.

The quotation should be valid for a minimum period of 90 days effective from the date of opening of tender, unless otherwise specified in the tender enquiry.

16. RIGHT OF ACCEPTANCE.

- a) **BHARAT HEAVY ELECTRICALS LIMITED HARIDWAR** reserves the right to reject any or all the bids / quotations without assigning any reason thereof. BHEL also reserves the right to increase or decrease the tendered quantities. Bidders should be prepared to accept order for reduced quantity without any extra charges.



BHARAT HEAVY ELECTRICALS LIMITED

HEEP-HARIDWAR, UTTARAKHAND (249403)

General Instructions and Standard Terms & Conditions for bidding against Tender Enquiry (GISTC)

For Indian Bidders (Version April-2019, Rev: 04)

- b) Any discount / revised offer / bids submitted by a bidder on its own shall be considered, provided it is received on or before the due date and time of offer / bid submission (Part-1). Conditional discounts shall not be considered for evaluation of tenders.
- c) Unsolicited discounts / revised offers / bids given after Part-1 bid opening shall not be accepted. No change in price will be permitted within the validity period asked for in the tender enquiry.
- d) In case of changes in scope and / or technical specification and / or commercial terms & conditions having price implication, techno-commercially acceptable bidders shall be asked by BHEL to submit the impact of such changes on their price bids. In case a bidder opts to submit revised price bid instead of impact called for then the latest price bid shall prevail. However, in both situations, original price bid will be necessarily opened.
- e) The bidder whose bid is technically not accepted will be informed & EMD wherever submitted shall be returned after finalization of contract. EMD shall be forfeited in the event of bidder opting out after tender opening.
- f) BHEL reserves the right to short close the existing Purchase Order / Rate Contract / Work Order or any extension thereof at any stage.

17. TRANSIT INSURANCE.

- a) Transit Insurance will be covered by BHEL under its open Insurance Policy. Seller shall inform dispatch particulars (Purchase Order, RR /GR, Invoice value etc.) to "Finance department (Store bill Section), BHEL Ranipur, Haridwar (Uttarakhand-India) with value of consignment to the Purchaser within 07 days of dispatch for BHEL to arrange insurance coverage in its policy. Failure on the part of seller to inform dispatch particulars will make him liable to pay for any transit damages / losses suffered by the Purchaser.

- b) If Quoted Prices are inclusive of transit insurance, no weightage shall be given while evaluating the bids for Cost of Insurance, being in BHEL Scope.

18. RISK PURCHASE.

In case of abnormal delays (beyond the maximum late delivery period as per Penalty clause) in supplies / defective supplies or non-fulfillment of any other terms and conditions given in Purchase Order, BHEL may cancel the Purchase Order in full or part thereof, and may also make the purchase of such material from elsewhere / alternative source at the risk and cost of the supplier. BHEL will take all reasonable steps to get the material from alternate source at optimum cost. If bidder does not agree to the above Risk Purchase Clause, BHEL reserves the right to reject the offer. In case for compelling reasons BHEL accepts the offer without acceptance of this clause by the bidder and in the eventuality of Risk Purchase, appropriate action will be taken as per BHEL extant rules. This will be without prejudice to any other right of BHEL under the contract.

19. FORCE MAJEURE CLAUSE.

Notwithstanding any other thing contained anywhere else in the contract or PO (Purchase Order), In case the discharge of obligation under the contract by either party is impeded or made unreasonably onerous, neither party shall be considered in breach of the contract to the extent that performance of their respective obligation is prevented by an event of Force Majeure that arises after the effective date (PO date).

In the above clause, Force Majeure means an event beyond the control of the parties to the contract which prevents a party from complying with any obligation of the contract including but not limited to:

- a) Act of God (Such as but not limited to earthquake, drought, tidal waves, floods etc.).
- b) War (whether war be declared or not), Hostilities Invasion, Act of foreign enemy etc.
- c) Rebellion, revolution, insurrection, civil war etc.



BHARAT HEAVY ELECTRICALS LIMITED

HEEP-HARIDWAR, UTTARAKHAND (249403)

General Instructions and Standard Terms & Conditions for bidding against Tender Enquiry (GISTC)

For Indian Bidders (Version April-2019, Rev: 04)

- d) Contamination of Radio Activity from any nuclear fuel or from any other nuclear waste or any other hazardous materials.
- e) Riots, commotions, strike unless restricted to the employees of supplier.
- f) Acts of terrorism.
- g) Other unforeseeable circumstances beyond the control of the parties and which the affected party cannot avoid even by using its best efforts.
- h) Cancellation of contract by customer.
- i) Change in law / government. Regulation making the performance impossible.

The party claiming to be affected by force majeure shall notify the other party in writing immediately without delay on the intervention and on the cessation of such circumstances.

Irrespective of any extension of time, if an event of force majeure occurs and its effect continues for more than 180 days the affected party shall have right to cancel the contract.

As soon as reasonably practicable following the date of commencement of a Force Majeure Event, and within a reasonable time following the date of termination of a Force Majeure Event, either Party invoking it shall submit to the other Party reasonable proof of the nature of the Force Majeure Event and of its effect upon the performance of the Party's obligations under this Agreement.

The party shall, and shall ensure that its Subcontractors shall, at all times take all reasonable steps within their respective powers and consistent with Good Operating Practices (but without incurring unreasonable additional costs) to:

- a) Prevent Force Majeure Events affecting the performance of the party's obligations under this Agreement.
- b) mitigate the effect of any Force Majeure Event and
- c) Comply with its obligations under this Agreement.

If the war like situation has developed in a country where a seller's works is located in this P.O. or there is political instability and Indian Embassy located in that country forbids or advises for not having any business dealing with the sellers located in such zone / region/ country, then BHEL reserves the right to cancel the order.

20. NON-DISCLOSURE AGREEMENT.

All Drawing and Technical Documents relating to the product or it's manufacture submitted by one party to the other, prior or subsequent to the formation of contract, shall remain property of the submitting party. Drawing, technical documents or other technical information received by one party, shall not without the consent of the other party, be used for any other purpose than that, for which they were provided. Such technical information shall not without the consent of the submitting party, otherwise be used or copied, reproduced, transmitted or communicated to a third party. Patterns supplied by BHEL will remain BHEL's property which shall be returned by the bidder on demand to BHEL. Bidder shall in no way share or use such intellectual property of BHEL to promote his own business with others. BHEL reserves the right to claim damages from the bidder, or take appropriate penal action as deemed fit against the bidder, for any infringement of the provisions contained herein.

21. SETTLEMENT OF DISPUTES / ARBITRATION.

In all cases of dispute, the matter shall be referred for ARBITRATION by sole arbitrator to be appointed by the Unit Head of Bharat Heavy Electricals Ltd., at HARIDWAR. The award of the Arbitrator shall be final and binding on both the parties. The place of Arbitration shall be Haridwar.

JURIDICTION: The courts of Haridwar, India, shall have exclusive jurisdiction.

22. WHARFAGE / DEMURRAGE RESPONSIBILITY.

In the event of delay in receipt of documents by Manager (Stores-Shipping) BHEL-Haridwar and in case where dispatches are made through Unapproved Transporter the sole responsibility for wharfage / demurrage for such delay shall be that of supplier.

23. CONDITIONS FOR AVAILING MICRO & SMALL ENTERPRISES (MSE'S) BENEFITS.

- a) "MSE Suppliers can avail the intended benefits only if they submit along with the offer, attested copies of either EM II certificate having deemed validity (**five years** from the date of



BHARAT HEAVY ELECTRICALS LIMITED

HEEP-HARIDWAR, UTTARAKHAND (249403)

General Instructions and Standard Terms & Conditions for bidding against Tender Enquiry (GISTC)

For Indian Bidders (Version April-2019, Rev: 04)

issue of acknowledgement in EM II) or valid NSIC certificate or EM II certificate along with attested copy of a CA certificate (Format enclosed at annexure-1 where deemed validity of EM II certificate of five years has expired) applicable for the relevant financial year (latest audited). Date to be reckoned for determining the deemed validity will be the date of bid opening (Part 1 in case of two-part bid) or vendor has to give Udyog Adhar Memorandum (UAM). Non submission of such documents will lead to consideration of their bid at par with other bidders. No benefit shall be applicable for this enquiry if any deficiency in the above required documents is found or the requisite documents are not submitted before price bid opening. If the tender is to be submitted through e-procurement portal, then the above require document are to be uploaded on the portal. Documents should be notarized or attested by a Gazetted officer. **UAM need not required to be notarized or attested.**

b) Any new supplier will be eligible for registration with BHEL as MSE supplier provided at least any one of the following documents are submitted along with application for registration: -

1. Udyog Adhar Memorandum (UAM).
2. Valid National Small Industries Commission (NSIC) Certificate.
3. Entrepreneurs Memorandum part II (EM II) certificate (valid based on deemed validity of 5 years) or
4. EM II certificate along with attested copy of CA Certificate (as per prescribed format at annexure-A) applicable for the relevant financial year (latest audited), where the deemed validity of EM II is over.
5. However, credentials of all MSE suppliers will be verified before advancing the intended benefits.
6. MSE bidders claiming SC/ST status will have to submit SC/ST certificate of the Proprietor from competent authority. Attested (notarized or attested by Gazetted officer) copy to be submitted along with the offer.
7. In case techno-commercial accepted bidders include MSE source and their prices (based on landed cost – considering quoted prices) are within the price band of 15% w.r.t. L-1 bidder, then BHEL can offer **25%** of quantity of respective item (rounded off to nearest number) to MSE bidders at L-1 price and in case, more than one MSE bidder is in 15 % band and the same is accepted by more than one MSE bidders then **25%**

quantities of respective items will be considered for ordering on proportionate basis amongst MSE bidders.

8. There will be minimum of **3%** reservation for women owned MSEs within the above mentioned 25% reservation.
9. The reservation for MSEs owned by SC/ST will be **6.25%** { 25% out of target of 25% - refer para 4 of Public Procurement Policy for the Micro and Small Enterprises(MSEs)}.
10. The definition of MSEs owned by Women Entrepreneurs is clarified as under:
 - a) In case of proprietary MSE, proprietor shall be Woman.
 - b) In case of partnership MSE, the Woman partners shall be holding at least 51% of share in the unit.
 - c) In case of Private Limited companies, at least 51% share shall be held by Women promoters.
11. The definition of MSEs owned by SC/ST is clarified as under:
 - a) In case of proprietary MSE, proprietor(s) shall be SC/ST.
 - b) In case of partnership MSE, the SC/ST partners shall be holding at least 51% of shares in the unit.
 - c) In case of Private Limited companies, at least 51% share shall be held by SC/ST promoters.
12. While distributing the **25%** quantity amongst MSE bidders the decimal points in quantity shall be ignored for all the bidders except the L-1 amongst MSE bidders. Balance quantity after allocating the quantity to other MSE bidders ignoring the quantities in decimal, shall be given to L-1 (amongst MSE) bidder. However, if there are more than one MSE bidder at the same price level than preference for additional quantities due to ignoring off the decimal (as mentioned above) shall be given to the bidder offering favorable terms to BHEL and if the conditions offered are also same then preference will be given to the bidder having high SPR rating.
13. In case there are more than one MSE bidders (with different landed cost to BHEL) within 15% price band of lowest bidder and quantity to be offered is 1 no. only, then preference shall be given to the MSE bidder with lowest landed cost.
14. In case there are more than one MSE bidders (with same landed cost to BHEL) within 15% price band of lowest bidder and quantity to be offered is 1 no. only, then preference shall be given first, based on the favorable terms in the bid and in case terms are also same, the bidder with high SPR rating shall be given preference.



BHARAT HEAVY ELECTRICALS LIMITED

HEEP-HARIDWAR, UTTARAKHAND (249403)

General Instructions and Standard Terms & Conditions for bidding against Tender Enquiry (GISTC)

For Indian Bidders (Version April-2019, Rev: 04)

15. If L1 bidder is MSE bidder, entire quantity will be given to such MSE bidder only.
16. Note: It may however be noted that MSE guidelines as on date (Date of Technical Bid Opening Part-1) shall prevail.
17. "As per the OM No. F.No. 1(2)(1)/2016-MA dtd. 09.02.2017 issued from the Office of Development Commissioner (Micro, Small & Medium Enterprises), "Traders and agents should not be allowed to avail the benefits extended under the PP Policy."

In view of this, it is clarified that benefits of MSE (such as EMD Waiver, Tender fee exemption, Price preference, Payment preference etc.) will be given only to those MSE Vendors who are manufacturers of offered items against the NIT. No MSE benefits shall be provided to Agents / Stockists / Dealers / Traders etc. for the items offered but not manufactured by themselves."

24. INFORMATION TO THE BIDDERS.

- a) Purchase related information is available at our Business-to-Business (B2B) Portal available on our website www.bhelhwr.co.in The user ID & password can be obtained by sending a request to concerned purchase executives.
- b) Intimate your change in mail address or communication address or changes, if any, by email to AGM (SDX/MM) giving your bidder Code.
- c) Please resolve your rejections and unexecuted overdue purchase order immediately which are posted at our B2B Portal, which can be visited through our site www.bhelhwr.co.in
- d) Copy of this Tender Enquiry is being sent through the post.

25. MAKE IN INDIA (GOVT-NOTIFICATION).

- A. This tender enquiry shall be governed by notification no. P-45021/2/2017-PP (BE-II) dated 28.05.2018 of government of INDIA. Accordingly, the minimum local content, the margin of purchase preference and the procedure for preference to make in INDIA shall be adhered.
- B. Default purchase preference shall be 20% to local suppliers with default minimum local content of 50% for all items / works / services unless any of the Nodal Ministry has

prescribed, or prescribe in future lower or higher percentage of purchase preference and/or local content in respect of any items / works / services in which case the purchase preference and/ or local content for that particular items / works / services shall be as prescribed by the Nodal Ministry.

- C. Vendor to specifically confirm if they are local supplier or not as per above mentioned notification. Accordingly, the local supplier at the time of tender, bidding or solicitation shall be required to provide self-certification that the item offered meets the minimum local content and shall give details of the location(s) at which the local value addition is made.

'Local Supplier' means a supplier or service provider whose product or service offered for procurement meets the minimum local content. 'Local Content' means the mount of value added in India, which shall, unless otherwise prescribed, be the total value of the item procured (excluding net domestic indirect taxes) minus the value of imported content in the item (including all custom duties) as a proportion of the total value, in percent.

- D. In cases of Procurement for a Value in Excess of Rs. 10 Crores, the Local Supplier shall be required to provide a Certificate from the Statutory Auditor or Cost Auditor of the Company (in the case of companies) or from a practicing Cost Accountant or practicing Chartered Accountant (in respect of suppliers other than companies) giving the percentage of Local Content.

- E. Requirement of Purchase Preference: Purchase preference shall be given to local suppliers in all procurements undertaken in the manner specified hereunder-

- a. "In Procurement of Goods, Services or Works in respect of which the Nodal Ministry has communicated that there is sufficient local capacity and local competition, and where the estimated value of procurement is Rs. 50 lakhs or less, only local suppliers shall be eligible. If the estimated value of procurement of such goods or services or works is more than Rs. 50 lakhs, the provisions of below sub-paragraph b or c, as the case may be, shall be apply".
- b. "In the procurements of goods or work which are not covered by above paragraph a and which are divisible in nature, the following procedure shall be followed";
 - i) Among all qualified bids, the lowest bid will be termed as L1. If L1 is from a local supplier, the contract for full quantity will be awarded to L1.

Quotations / Bids not in accordance with General Instructions and Standard Terms & Conditions are likely to be ignored.



BHARAT HEAVY ELECTRICALS LIMITED

HEEP-HARIDWAR, UTTARAKHAND (249403)

General Instructions and Standard Terms & Conditions for bidding against Tender Enquiry (GISTC)

For Indian Bidders (Version April-2019, Rev: 04)

- ii) If L1 bid is not from a local supplier, 50% of the order quantity shall be awarded to L1. Thereafter, the lowest bidder among the local suppliers will be invited to match the L1 price for the remaining 50% quantity subject to the local suppliers quoted price falling within the margin of purchase preference, and contract for that quantity shall be awarded to such local supplier subject to matching the L1 price. In case such lowest eligible local supplier fails to match the L1 price or accepts less than the offered quantity, the next higher local supplier within the margin of purchase preferences shall be invited to match the L1 price for remaining quantity and so on, and contract shall be awarded accordingly. In case some quantity is still left uncovered on local suppliers, then such balance quantity may also be ordered on the L1 bidder.
- c. "In procurements of goods or works not covered by sub-paragraph E.a) and which are not divisible and in procurement of services where the bid is evaluated on price alone, the following procedure shall be followed":-
- i) Among all qualified bids, the lowest bid will be termed as L1. If L1 is from a local supplier, the contract will be awarded to L1
- ii) If L1 is not from a local supplier, the lowest bidder among the local suppliers will be invited to match the L1 price subject to local supplier's quoted price, falling within the margin of purchase preference, and the contract shall be awarded to such local supplier subject to matching the L1 price.
- iii) In case such lowest eligible local supplier fails to match the L1 price, the local supplier with the next higher bid within the margin of purchase preference shall be invited to match the L1 price and so on and contract shall be awarded accordingly. In case none of the local suppliers within the margin of purchase preference matches the L1 price, then the contract may be awarded to the L1 bidder.
- F. "For this procurement, Public Procurement (Preference to Make in India), Order 2017 dated 15.06.2017 & 28.05.2018 and subsequent Orders issued by the respective Nodal Ministry shall be applicable even if issued after issue of this NIT but before finalization of contract / PO / WP against this NIT.

In the event of any Nodal Ministry prescribing higher or lower percentage of purchase preference and/ or local content in respect of this procurement, same shall be applicable."

- G. Procurements where estimated value to be procured is less than Rs. 5 lakhs shall be exempted from GOI order No. P-45021/2/2017-PP (BE-II) dated 28.05.2018
- H. For procurement of Goods & Services which are divisible in nature, following shall be operated for **MSE bidders** under Public procurement (Preference to make in India), Order 2017 (revision) :-
- a. If L1 bid is not from local Supplier and price quoted by MSE bidder falls within the margin of Purchase preference (L1+15% for MSEs), then 25 % of total order quantity of respective item (rounded off to nearest number) shall be awarded to MSE bidder, subject to MSE bidder matching the L1 Price. Out of Remaining 75% quantity, distribution shall be operated as per below sub-clause (2) -
- b. If Local Supplier (Next to L1, other than MSE) quoted price falling within the Margin of Purchase Preference, and local supplier matches the L1 price, then 50% of remaining Quantity (after allocation of 25% to MSE) i.e. 37.5% shall be awarded to local supplier and 37.5% shall be awarded to Foreign bidder.

Note : L1 Price refers to lowest evaluated / landed cost to company.

For Further details, please refer GOI order no. P-45021 / 2 / 2017 - PP (BE-II) dated 28.05.2018.

26. NOTE.

- a) Special conditions of enquiry, if enclosed by BHEL, will supersede the respective standard / general terms of enquiry.
- b) Any other Standard terms and Conditions of the bidder attached / referred against the tender enquiry will be treated as null and void ab initio.
- c) In order to protect the commercial interests of BHEL, it becomes necessary to take action against suppliers / contractors by way of supervision of business dealings, who either fail to perform or are in default without any reasonable cause, cause loss of business / money / reputation, indulged in malpractices, cheating, bribery, fraud or any other



BHARAT HEAVY ELECTRICALS LIMITED

HEEP-HARIDWAR, UTTARAKHAND (249403)

General Instructions and Standard Terms & Conditions for bidding against Tender Enquiry (GISTC)

For Indian Bidders (Version April-2019, Rev: 04)

misconducts or formation of cartel so as to influence the bidding process or influence the price etc. Guide- lines for Suspension of Business Dealings with Suppliers / Contractors shall prevail over which is available at BHEL website <http://www.bhel.com>

d) The bidder along with its associate / collaborators / sub-contractors / sub-vendors / consultants / service providers shall strictly adhere to BHEL Fraud Prevention Policy displayed on BHEL website <http://www.bhel.com> and shall immediately bring to the notice of BHEL-Management about any fraud or suspected fraud as soon as it comes to their notice.

e) "BHEL shall recover the amount of compensation paid to victim(s) by BHEL towards loss of life / permanent disability due to an accident which is attributable to the negligence of contractor, agency or firm or any of its employees as detailed below;

1. **Victim:** Any person who suffers permanent disablement or dies in an accident as defined below.

2. **Accident:** Any death or permanent disability resulting solely and directly from any unintended and unforeseen injurious occurrence caused during the manufacturing / operation and works incidental thereto at BHEL factories/ **offices and precincts** thereof , project execution , erection and commissioning, services, repairs and maintenance, trouble shooting, serving , overhaul, renovation and retrofitting , trial operation, performance guarantee testing undertaken by the company or during any works / during working at BHEL Units/ Offices/ townships and premises/ project sites.

3. **Compensation in respect of each of the victims:**

(i) In the event of death or **permanent disability** resulting from **Loss of both limbs:** Rs. 10,00,000/- (Rs. Ten Lakh).

(ii) In the event of **other permanent disability:** Rs. 7,00,000/- (Rs. Seven Lakh).

4. **Permanent Disablement:** A disablement that is classified as a permanent total disablement under the proviso to Section 2(l) of the Employees Compensation Act, 1923."

Annexure-4

No. P-45021/2/2017-B.E.-II
Government of India
Ministry of Commerce and Industry
Department of Industrial Policy and Promotion

Dated 15th June, 2017
Udyog Bhawan, New Delhi

To

All Central Ministries/Departments/CPSUs/All concerned

ORDER

Subject: Public Procurement (Preference to Make in India), Order 2017

Whereas it is the policy of the Government of India to encourage 'Make in India' and promote manufacturing and production of goods and services in India with a view to enhancing income and employment, and

Whereas procurement by the Government is substantial in amount and can contribute towards this policy objective, and

Whereas local content can be increased through partnerships, cooperation with local companies, establishing production units in India or Joint Ventures (JV) with Indian suppliers, increasing the participation of local employees in services and training them,

Now therefore the following Order is issued :

1. This Order is issued pursuant to Rule 153 (iii) of the General Financial Rules 2017.
2. **Definitions:** For the purposes of this Order:

'Local content' means the amount of value added in India which shall, unless otherwise prescribed by the Nodal Ministry, be the total value of the item procured (excluding net domestic indirect taxes) minus the value of imported content in the item (including all customs duties) as a proportion of the total value, in percent.

'Local supplier' means a supplier or service provider whose product or service offered for procurement meets the minimum local content as prescribed under this Order or by the competent Ministries / Departments in pursuance of this order.

'L1' means the lowest tender or lowest bid or the lowest quotation received in a tender, bidding process or other procurement solicitation as adjudged in the evaluation process as per the tender or other procurement solicitation.

'margin of purchase preference' means the maximum extent to which the price quoted by a local supplier may be above the L1 for the purpose of purchase preference.

'Nodal Ministry' means the Ministry or Department identified pursuant to this order in respect of a particular item of goods or services.

..... Contd. p.2/-

'Procuring entity' means a Ministry or department or attached or subordinate office of, or autonomous body controlled by, the Government of India and includes Government companies as defined in the Companies Act.

3. **Requirement of Purchase Preference:** Subject to the provisions of this Order and to any specific instructions issued by the Nodal Ministry or in pursuance of this Order, purchase preference shall be given to local suppliers in all procurements undertaken by procuring entities in the manner specified hereunder:
- a. In procurement of goods in respect of which the Nodal Ministry has communicated that there is sufficient local capacity and local competition, and where the estimated value of procurement is Rs. 50 lakhs or less, only local suppliers shall be eligible. If the estimated value of procurement of such goods is more than Rs. 50 lakhs, the provisions of sub-paragraph b or c, as the case may be, shall apply.
 - b. In the procurements of goods which are not covered by paragraph 3a and which are divisible in nature, the following procedure shall be followed:
 - i. Among all qualified bids, the lowest bid will be termed as L1. If L1 is from a local supplier, the contract for full quantity will be awarded to L1.
 - ii. If L1 bid is not from a local supplier, 50% of the order quantity shall be awarded to L1. Thereafter, the lowest bidder among the local suppliers, will be invited to match the L1 price for the remaining 50% quantity subject to the local supplier's quoted price falling within the margin of purchase preference, and contract for that quantity shall be awarded to such local supplier subject to matching the L1 price. In case such lowest eligible local supplier fails to match the L1 price or accepts less than the offered quantity, the next higher local supplier within the margin of purchase preference shall be invited to match the L1 price for remaining quantity and so on, and contract shall be awarded accordingly. In case some quantity is still left uncovered on local suppliers, then such balance quantity may also be ordered on the L1 bidder.
 - c. In procurements of goods not covered by sub-paragraph 3a and which are not divisible, and in procurement of services where the bid is evaluated on price alone, the following procedure shall be followed:
 - i. Among all qualified bids, the lowest bid will be termed as L1. If L1 is from a local supplier, the contract will be awarded to L1.
 - ii. If L1 is not from a local supplier, the lowest bidder among the local suppliers, will be invited to match the L1 price subject to local supplier's quoted price falling within the margin of purchase preference, and the contract shall be awarded to such local supplier subject to matching the L1 price.
 - iii. In case such lowest eligible local supplier fails to match the L1 price, the local supplier with the next higher bid within the margin of purchase preference shall be invited to match the L1 price and so on and contract shall be awarded accordingly. In case none of the local suppliers within the margin of purchase preference matches the L1 price, then the contract may be awarded to the L1 bidder.

4. **Exemption of small purchases:** Notwithstanding anything contained in paragraph 3, procurements where the estimated value to be procured is less than Rs. 5 lakhs shall be exempt from this Order. However, it shall be ensured by procuring entities that procurement is not split for the purpose of avoiding the provisions of this Order.
5. **Minimum local content:** The minimum local content shall ordinarily be 50%. The Nodal Ministry may prescribe a higher or lower percentage in respect of any particular item and may also prescribe the manner of calculation of local content.
6. **Margin of Purchase Preference:** The margin of purchase preference shall be 20% .
7. **Requirement for specification in advance:** The minimum local content, the margin of purchase preference and the procedure for preference to Make in India shall be specified in the notice inviting tenders or other form of procurement solicitation and shall not be varied during a particular procurement transaction.
8. **Government E-marketplace:** In respect of procurement through the Government E-marketplace (GeM) shall, as far as possible, specifically mark the items which meet the minimum local content while registering the item for display, and shall, wherever feasible, make provision for automated comparison with purchase preference and without purchase preference and for obtaining consent of the local supplier in those cases where purchase preference is to be exercised.
9. **Verification of local content:**
 - a. The local supplier at the time of tender, bidding or solicitation shall be required to provide self-certification that the item offered meets the minimum local content and shall give details of the location(s) at which the local value addition is made.
 - b. In cases of procurement for a value in excess of Rs. 10 crores, the local supplier shall be required to provide a certificate from the statutory auditor or cost auditor of the company (in the case of companies) or from a practicing cost accountant or practicing chartered accountant (in respect of suppliers other than companies) giving the percentage of local content.
 - c. Decisions on complaints relating to implementation of this Order shall be taken by the competent authority which is empowered to look into procurement-related complaints relating to the procuring entity.
 - d. Nodal Ministries may constitute committees with internal and external experts for independent verification of self-declarations and auditor's/ accountant's certificates on random basis and in the case of complaints.
 - e. Nodal Ministries and procuring entities may prescribe fees for such complaints.
 - f. False declarations will be in breach of the Code of Integrity under Rule 175(1)(i)(h) of the General Financial Rules for which a bidder or its successors can be debarred for up to two years as per Rule 151 (iii) of the General Financial Rules along with such other actions as may be permissible under law.
 - g. A supplier who has been debarred by any procuring entity for violation of this Order shall not be eligible for preference under this Order for procurement by any other procuring entity for the

duration of the debarment. The debarment for such other procuring entities shall take effect prospectively from the date on which it comes to the notice of other procurement entities, in the manner prescribed under paragraph 9h below.

- h. The Department of Expenditure shall issue suitable instructions for the effective and smooth operation of this process, so that:
 - i. The fact and duration of debarment for violation of this Order by any procuring entity are promptly brought to the notice of the Member-Convenor of the Standing Committee and the Department of Expenditure through the concerned Ministry /Department or in some other manner;
 - ii. on a periodical basis such cases are consolidated and a centralized list or decentralized lists of such suppliers with the period of debarment is maintained and displayed on website(s);
 - iii. in respect of procuring entities other than the one which has carried out the debarment, the debarment takes effect prospectively from the date of uploading on the website(s) in the such a manner that ongoing procurements are not disrupted.

10. Specifications in Tenders and other procurement solicitations:

- a. Every procuring entity shall ensure that the eligibility conditions in respect of previous experience fixed in any tender or solicitation do not require proof of supply in other countries or proof of exports.
- b. Procuring entities shall endeavour to see that eligibility conditions, including on matters like turnover, production capability and financial strength do not result in unreasonable exclusion of local suppliers who would otherwise be eligible, beyond what is essential for ensuring quality or creditworthiness of the supplier.
- c. Procuring entities shall, within 2 months of the issue of this Order review all existing eligibility norms and conditions with reference to sub-paragraphs 'a' and 'b' above.
- d. If a Nodal Ministry is satisfied that Indian suppliers of an item are not allowed to participate and/ or compete in procurement by any foreign government, it may, if it deems appropriate, restrict or exclude bidders from that country from eligibility for procurement of that item and/ or other items relating to that Nodal Ministry. A copy of every instruction or decision taken in this regard shall be sent to the Chairman of the Standing Committee.
- e. For the purpose of sub-paragraph 10 d above, a supplier or bidder shall be considered to be from a country if (i) the entity is incorporated in that country, or (ii) a majority of its shareholding or effective control of the entity is exercised from that country; or (iii) more than 50% of the value of the item being supplied has been added in that country. Indian suppliers shall mean those entities which meet any of these tests with respect to India."

11. **Assessment of supply base by Nodal Ministries:** The Nodal Ministry shall keep in view the domestic manufacturing / supply base and assess the available capacity and the extent of local competition while identifying items and prescribing minimum local content or the manner of its calculation, with a view to avoiding cost increase from the operation of this Order.
12. **Increase in minimum local content:** The Nodal Ministry may annually review the local content requirements with a view to increasing them, subject to availability of sufficient local competition with adequate quality.
13. **Manufacture under license/ technology collaboration agreements with phased indigenization:** While notifying the minimum local content, Nodal Ministries may make special provisions for exempting suppliers from meeting the stipulated local content if the product is being manufactured in India under a license from a foreign manufacturer who holds intellectual property rights and where there is a technology collaboration agreement / transfer of technology agreement for indigenous manufacture of a product developed abroad with clear phasing of increase in local content.
14. **Powers to grant exemption and to reduce minimum local content:** Ministries /Departments of Government of India and the Boards of Directors of Government companies or autonomous bodies may, by written order,
 - a. reduce the minimum local content below the prescribed level;
 - b. reduce the margin of purchase preference below 20% ;
 - c. exempt any particular item or procuring or supplying entities or class or classes of items or procuring or supplying entities from the operation of this Order or any part of the Order.

A copy of every such order shall be marked to the Member-Convenor of the Standing Committee constituted under this Order.

15. **Directions to Government companies:** In respect of Government companies and other procuring entities not governed by the General Financial Rules, the administrative Ministry or Department shall issue policy directions requiring compliance with this Order.
16. **Standing Committee:** A standing committee is hereby constituted with the following membership:

Secretary, Department of Industrial Policy and Promotion—Chairman
Secretary, Commerce—Member
Secretary, Ministry of Electronics and Information Technology—Member
Joint Secretary (Public Procurement), Department of Expenditure—Member
Joint Secretary (DIPP)—Member-Convenor

The Secretary of the Department concerned with a particular item shall be a member in respect of issues relating to such item. The Chairman of the Committee may co-opt technical experts as relevant to any issue or class of issues under its consideration.

17. **Functions of the Standing Committee:** The Standing Committee shall meet as often as necessary but not less than once in six months. The Committee
- a. shall oversee the implementation of this order and issues arising therefrom, and make recommendations to Nodal Ministries and procuring entities.
 - b. shall annually assess and periodically monitor compliance with this Order
 - c. shall identify Nodal Ministries and the allocation of items among them for issue of notifications on minimum local content
 - d. may require furnishing of details or returns regarding compliance with this Order and related matters
 - e. may, during the annual review or otherwise, assess issues, if any, where it is felt that the manner of implementation of the order results in any restrictive practices, cartelization or increase in public expenditure and suggest remedial measures
 - f. may examine cases covered by paragraph 13 above relating to manufacture under license/ technology transfer agreements with a view to satisfying itself that adequate mechanisms exist for enforcement of such agreements and for attaining the underlying objective of progressive indigenization
 - g. may consider any other issue relating to this Order which may arise.
18. **Removal of difficulties:** Ministries /Departments and the Boards of Directors of Government companies may issue such clarifications and instructions as may be necessary for the removal of any difficulties arising in the implementation of this Order.
19. **Ministries having existing policies:** Where any Ministry or Department has its own policy for preference to local content approved by the Cabinet after 1st January 2015, such policies will prevail over the provisions of this Order. All other existing orders on preference to local content shall be reviewed by the Nodal Ministries and revised as needed to conform to this Order, within two months of the issue of this Order.
20. **Transitional provision:** This Order shall not apply to any tender or procurement for which notice inviting tender or other form of procurement solicitation has been issued before the issue of this Order.

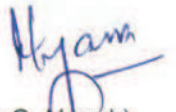

(B. S. Nayak)
Under Secretary to Government of India
Ph. 23061257

No. P-45021/2/2017-PP (BE-II)
Government of India
Ministry of Commerce and Industry
Department of Industrial Policy and Promotion
(Public Procurement Section)

Dated 28th May, 2018
Udyog Bhawan, New Delhi

To
All Central Ministries/Departments/CPSUs/All concerned

ORDER

**Subject: Public Procurement (Preference to Make in India), Order 2017 – Revision;
regarding.**

Department of Industrial Policy and Promotion, in partial modification of Order No.P-45021/2/2017-B.E.-II dated 15.6.2017, hereby issues the revised 'Public Procurement (Preference to Make in India), Order 2017' with immediate effect:-

Whereas it is the policy of the Government of India to encourage 'Make in India' and promote manufacturing and production of goods and services in India with a view to enhancing income and employment, and

Whereas procurement by the Government is substantial in amount and can contribute towards this policy objective, and

Whereas local content can be increased through partnerships, cooperation with local companies, establishing production units in India or Joint Ventures (JV) with Indian suppliers, increasing the participation of local employees in services and training them,

Now therefore the following Order is issued :

1. This Order is issued pursuant to Rule 153 (iii) of the General Financial Rules 2017.
2. **Definitions:** For the purposes of this Order:

'Local content' means the amount of value added in India which shall, unless otherwise prescribed by the Nodal Ministry, be the total value of the item procured (excluding net domestic indirect taxes) minus the value of imported content in the item (including all customs duties) as a proportion of the total value, in percent.

'Local supplier' means a supplier or service provider whose product or service offered for procurement meets the minimum local content as prescribed under this Order or by the competent Ministries / Departments in pursuance of this order.

'L1' means the lowest tender or lowest bid or the lowest quotation received in a tender, bidding process or other procurement solicitation as adjudged in the evaluation process as per the tender or other procurement solicitation.

'margin of purchase preference' means the maximum extent to which the price quoted by a local supplier may be above the L1 for the purpose of purchase preference.

.....Contd. p/2

'Nodal Ministry' means the Ministry or Department identified pursuant to this order in respect of a particular item of goods or services or works.

'Procuring entity' means a Ministry or department or attached or subordinate office of, or autonomous body controlled by, the Government of India and includes Government companies as defined in the Companies Act.

'Works' means all works as per Rule 130 of GFR- 2017, and will also include 'turnkey works'.

3. Requirement of Purchase Preference : Subject to the provisions of this Order and to any specific instructions issued by the Nodal Ministry or in pursuance of this Order, purchase preference shall be given to local suppliers in all procurements undertaken by procuring entities in the manner specified hereunder"

- a. "In procurement of goods, services or works in respect of which the Nodal Ministry has communicated that there is sufficient local capacity and local competition, and where the estimated value of procurement is Rs. 50 lakhs or less, only local suppliers shall be eligible. If the estimated value of procurement of such goods or services or works is more than Rs. 50 lakhs, the provisions of sub-paragraph b or c, as the case may be, shall apply";
- b. "In the procurements of goods or works which are not covered by paragraph 3a and which are divisible in nature, the following procedure shall be followed";
 - i. Among all qualified bids, the lowest bid will be termed as L1. If L1 is from a local supplier, the contract for full quantity will be awarded to L1.
 - ii. If L1 bid is not from a local supplier, 50% of the order quantity shall be awarded to L1. Thereafter, the lowest bidder among the local suppliers, will be invited to match the L1 price for the remaining 50% quantity subject to the local supplier's quoted price falling within the margin of purchase preference, and contract for that quantity shall be awarded to such local supplier subject to matching the L1 price. In case such lowest eligible local supplier fails to match the L1 price or accepts less than the offered quantity, the next higher local supplier within the margin of purchase preference shall be invited to match the L1 price for remaining quantity and so on, and contract shall be awarded accordingly. In case some quantity is still left uncovered on local suppliers, then such balance quantity may also be ordered on the L1 bidder.
- c. "In procurements of goods or works not covered by sub-paragraph 3a and which are not divisible, and in procurement of services where the bid is evaluated on price alone, the following procedure shall be followed":-
 - i. Among all qualified bids, the lowest bid will be termed as L1. If L1 is from a local supplier, the contract will be awarded to L1.

.....Contd. p/3

- ii. If L1 is not from a local supplier, the lowest bidder among the local suppliers, will be invited to match the L1 price subject to local supplier's quoted price falling within the margin of purchase preference, and the contract shall be awarded to such local supplier subject to matching the L1 price.
 - iii. In case such lowest eligible local supplier fails to match the L1 price, the local supplier with the next higher bid within the margin of purchase preference shall be invited to match the L1 price and so on and contract shall be awarded accordingly. In case none of the local suppliers within the margin of purchase preference matches the L1 price, then the contract may be awarded to the L1 bidder.
4. **Exemption of small purchases:** Notwithstanding anything contained in paragraph 3, procurements where the estimated value to be procured is less than Rs. 5 lakhs shall be exempt from this Order. However, it shall be ensured by procuring entities that procurement is not split for the purpose of avoiding the provisions of this Order.
5. **Minimum local content:** The minimum local content shall ordinarily be 50%. The Nodal Ministry may prescribe a higher or lower percentage in respect of any particular item and may also prescribe the manner of calculation of local content.
6. **Margin of Purchase Preference:** The margin of purchase preference shall be 20% .
7. **Requirement for specification in advance:** The minimum local content, the margin of purchase preference and the procedure for preference to Make in India shall be specified in the notice inviting tenders or other form of procurement solicitation and shall not be varied during a particular procurement transaction.
8. **Government E-marketplace:** In respect of procurement through the Government E-marketplace (GeM) shall, as far as possible, specifically mark the items which meet the minimum local content while registering the item for display, and shall, wherever feasible, make provision for automated comparison with purchase preference and without purchase preference and for obtaining consent of the local supplier in those cases where purchase preference is to be exercised.
9. **Verification of local content:**
 - a. The local supplier at the time of tender, bidding or solicitation shall be required to provide self-certification that the item offered meets the minimum local content and shall give details of the location(s) at which the local value addition is made.
 - b. In cases of procurement for a value in excess of Rs. 10 crores, the local supplier shall be required to provide a certificate from the statutory auditor or cost auditor of the company (in the case of companies) or from a practicing cost accountant or practicing chartered accountant (in respect of suppliers other than companies) giving the percentage of local content.
 - c. Decisions on complaints relating to implementation of this Order shall be taken by the competent authority which is empowered to look into procurement-related complaints relating to the procuring entity.

.....Contd. p/4

- d. Nodal Ministries may constitute committees with internal and external experts for independent verification of self-declarations and auditor's/ accountant's certificates on random basis and in the case of complaints.
- e. Nodal Ministries and procuring entities may prescribe fees for such complaints.
- f. False declarations will be in breach of the Code of Integrity under Rule 175(1)(i)(h) of the General Financial Rules for which a bidder or its successors can be debarred for up to two years as per Rule 151 (iii) of the General Financial Rules along with such other actions as may be permissible under law.
- g. A supplier who has been debarred by any procuring entity for violation of this Order shall not be eligible for preference under this Order for procurement by any other procuring entity for the duration of the debarment. The debarment for such other procuring entities shall take effect prospectively from the date on which it comes to the notice of other procurement entities, in the manner prescribed under paragraph 9h below.
- h. The Department of Expenditure shall issue suitable instructions for the effective and smooth operation of this process, so that:
 - i. The fact and duration of debarment for violation of this Order by any procuring entity are promptly brought to the notice of the Member-Convenor of the Standing Committee and the Department of Expenditure through the concerned Ministry /Department or in some other manner;
 - ii. on a periodical basis such cases are consolidated and a centralized list or decentralized lists of such suppliers with the period of debarment is maintained and displayed on website(s);
 - iii. in respect of procuring entities other than the one which has carried out the debarment, the debarment takes effect prospectively from the date of uploading on the website(s) in the such a manner that ongoing procurements are not disrupted.

10. Specifications in Tenders and other procurement solicitations:

- a. Every procuring entity shall ensure that the eligibility conditions in respect of previous experience fixed in any tender or solicitation do not require proof of supply in other countries or proof of exports.
- b. Procuring entities shall endeavour to see that eligibility conditions, including on matters like turnover, production capability and financial strength do not result in unreasonable exclusion of local suppliers who would otherwise be eligible, beyond what is essential for ensuring quality or creditworthiness of the supplier.
- c. Procuring entities shall, within 2 months of the issue of this Order review all existing eligibility norms and conditions with reference to sub-paragraphs 'a' and 'b' above.
- d. If a Nodal Ministry is satisfied that Indian suppliers of an item are not allowed to participate and/ or compete in procurement by any foreign government, it may, if it deems appropriate, restrict or exclude bidders from that country from eligibility for procurement of that item and/ or other items relating to that Nodal Ministry. A copy of every instruction or decision taken in this regard shall be sent to the Chairman of the Standing Committee.

.....Contd. p/5

e. For the purpose of sub-paragraph 10 d above, a supplier or bidder shall be considered to be from a country if (i) the entity is incorporated in that country, or (ii) a majority of its shareholding or effective control of the entity is exercised from that country; or (iii) more than 50% of the value of the item being supplied has been added in that country. Indian suppliers shall mean those entities which meet any of these tests with respect to India."

11. **Assessment of supply base by Nodal Ministries:** The Nodal Ministry shall keep in view the domestic manufacturing / supply base and assess the available capacity and the extent of local competition while identifying items and prescribing minimum local content or the manner of its calculation, with a view to avoiding cost increase from the operation of this Order.
12. **Increase in minimum local content:** The Nodal Ministry may annually review the local content requirements with a view to increasing them, subject to availability of sufficient local competition with adequate quality.
13. **Manufacture under license/ technology collaboration agreements with phased indigenization:** While notifying the minimum local content, Nodal Ministries may make special provisions for exempting suppliers from meeting the stipulated local content if the product is being manufactured in India under a license from a foreign manufacturer who holds intellectual property rights and where there is a technology collaboration agreement / transfer of technology agreement for indigenous manufacture of a product developed abroad with clear phasing of increase in local content.
14. **Powers to grant exemption and to reduce minimum local content:** Ministries /Departments of Government of India and the Boards of Directors of Government companies or autonomous bodies may, by written order,
 - a. reduce the minimum local content below the prescribed level;
 - b. reduce the margin of purchase preference below 20% ;
 - c. exempt any particular item or procuring or supplying entities or class or classes of items or procuring or supplying entities from the operation of this Order or any part of the Order.

A copy of every such order shall be marked to the Member-Convenor of the Standing Committee constituted under this Order.
15. **Directions to Government companies:** In respect of Government companies and other procuring entities not governed by the General Financial Rules, the administrative Ministry or Department shall issue policy directions requiring compliance with this Order.
16. **Standing Committee:** A standing committee is hereby constituted with the following membership:

Secretary, Department of Industrial Policy and Promotion—Chairman
Secretary, Commerce—Member
Secretary, Ministry of Electronics and Information Technology—Member
Joint Secretary (Public Procurement), Department of Expenditure—Member
Joint Secretary (DIPP)—Member-Convenor

The Secretary of the Department concerned with a particular item shall be a member in respect of issues relating to such item. The Chairman of the Committee may co-opt technical experts as relevant to any issue or class of issues under its consideration.

17. **Functions of the Standing Committee:** The Standing Committee shall meet as often as necessary but not less than once in six months. The Committee
- a. shall oversee the implementation of this order and issues arising therefrom, and make recommendations to Nodal Ministries and procuring entities.
 - b. shall annually assess and periodically monitor compliance with this Order
 - c. shall identify Nodal Ministries and the allocation of items among them for issue of notifications on minimum local content
 - d. may require furnishing of details or returns regarding compliance with this Order and related matters
 - e. may, during the annual review or otherwise, assess issues, if any, where it is felt that the manner of implementation of the order results in any restrictive practices, cartelization or increase in public expenditure and suggest remedial measures
 - f. may examine cases covered by paragraph 13 above relating to manufacture under license/ technology transfer agreements with a view to satisfying itself that adequate mechanisms exist for enforcement of such agreements and for attaining the underlying objective of progressive indigenization
 - g. may consider any other issue relating to this Order which may arise.
18. **Removal of difficulties:** Ministries /Departments and the Boards of Directors of Government companies may issue such clarifications and instructions as may be necessary for the removal of any difficulties arising in the implementation of this Order.
19. **Ministries having existing policies:** Where any Ministry or Department has its own policy for preference to local content approved by the Cabinet after 1st January 2015, such policies will prevail over the provisions of this Order. All other existing orders on preference to local content shall be reviewed by the Nodal Ministries and revised as needed to conform to this Order, within two months of the issue of this Order.
20. **Transitional provision:** This Order shall not apply to any tender or procurement for which notice inviting tender or other form of procurement solicitation has been issued before the issue of this Order.



(B. S. Nayak)

Under Secretary to Government of India
Ph. 23061257

No. P-45021/2/2017-PP (BE-II)
Government of India
Ministry of Commerce and Industry
Department for Promotion of Industry and Internal Trade
(Public Procurement Section)

Udyog Bhawan, New Delhi
Dated: 29th May, 2019

To

All Central Ministries/Departments/CPSUs/All concerned

ORDER

Subject: Public Procurement (Preference to Make in India), Order 2017 – Revision; regarding.

Department for Promotion of Industry and Internal Trade, in partial modification [Paras 3(a) and 14 modified and Para 10A added] of Order No.P-45021/2/2017-B.E.-II dated 15.6.2017 as amended by Order No.P-45021/2/2017-B.E.-II dated 28.05.2018, hereby issues the revised 'Public Procurement (Preference to Make in India), Order 2017" with immediate effect:-

Whereas it is the policy of the Government of India to encourage 'Make in India' and promote manufacturing and production of goods and services in India with a view to enhancing income and employment, and

Whereas procurement by the Government is substantial in amount and can contribute towards this policy objective, and

Whereas local content can be increased through partnerships, cooperation with local companies, establishing production units in India or Joint Ventures (JV) with Indian suppliers, increasing the participation of local employees in services and training them,

Now therefore the following Order is issued :

1. This Order is issued pursuant to Rule 153 (iii) of the General Financial Rules 2017.
2. **Definitions:** For the purposes of this Order:

'Local content' means the amount of value added in India which shall, unless otherwise prescribed by the Nodal Ministry, be the total value of the item procured (excluding net domestic indirect taxes) minus the value of imported content in the item (including all customs duties) as a proportion of the total value, in percent.

'Local supplier' means a supplier or service provider whose product or service offered for procurement meets the minimum local content as prescribed under this Order or by the competent Ministries / Departments in pursuance of this order.

'L1' means the lowest tender or lowest bid or the lowest quotation received in a tender, bidding process or other procurement solicitation as adjudged in the evaluation process as per the tender or other procurement solicitation.

'margin of purchase preference' means the maximum extent to which the price quoted by a local supplier may be above the L1 for the purpose of purchase preference.

'Nodal Ministry' means the Ministry or Department identified pursuant to this order in respect of a particular item of goods or services or works.

.....Contd. p/2

'Procuring entity' means a Ministry or department or attached or subordinate office of, or autonomous body controlled by, the Government of India and includes Government companies as defined in the Companies Act.

'Works' means all works as per Rule 130 of GFR- 2017, and will also include 'turnkey works'.

3. Requirement of Purchase Preference : Subject to the provisions of this Order and to any specific instructions issued by the Nodal Ministry or in pursuance of this Order, purchase preference shall be given to local suppliers in all procurements undertaken by procuring entities in the manner specified hereunder

a. In procurement of all goods, services or works in respect of which the estimated value of procurement is less than INR 50 Lakhs, only local suppliers shall be eligible to bid. However, in procurement of all goods, services or works, in respect of which the Nodal Ministry / Department has communicated that there is sufficient local capacity and local competition, only local suppliers shall be eligible to bid irrespective of purchase value.

Provided that for any particular item, the Nodal Ministry / Department may also prescribe an upper threshold limit, below which procurement shall be made only from local suppliers.

Further provided that in any particular case of procurement, if the procuring authority is of the view that the goods, services or works of required quality / specifications etc. may not be available in the country, or sufficient capacity or competition does not exist domestically, and it is necessary to undertake global competitive bidding, the procuring authority may allow the same after recording reasons. In such cases, the provisions of sub-paragraph b or c, as the case may be, shall apply;

b. In the procurements of goods or works which are not covered by paragraph 3a and which are divisible in nature, the following procedure shall be followed;

- i. Among all qualified bids, the lowest bid will be termed as L1. If L1 is from a local supplier, the contract for full quantity will be awarded to L1.
- ii. If L1 bid is not from a local supplier, 50% of the order quantity shall be awarded to L1. Thereafter, the lowest bidder among the local suppliers, will be invited to match the L1 price for the remaining 50% quantity subject to the local supplier's quoted price falling within the margin of purchase preference, and contract for that quantity shall be awarded to such local supplier subject to matching the L1 price. In case such lowest eligible local supplier fails to match the L1 price or accepts less than the offered quantity, the next higher local supplier within the margin of purchase preference shall be invited to match the L1 price for remaining quantity and so on, and contract shall be awarded accordingly. In case some quantity is still left uncovered on local suppliers, then such balance quantity may also be ordered on the L1 bidder.

c. In procurements of goods or works not covered by sub-paragraph 3a and which are not divisible, and in procurement of services where the bid is evaluated on price alone, the following procedure shall be followed:-

- i. Among all qualified bids, the lowest bid will be termed as L1. If L1 is from a local supplier, the contract will be awarded to L1.

.....Contd. p/3

- ii. If L1 is not from a local supplier, the lowest bidder among the local suppliers, will be invited to match the L1 price subject to local supplier's quoted price falling within the margin of purchase preference, and the contract shall be awarded to such local supplier subject to matching the L1 price.
 - iii. In case such lowest eligible local supplier fails to match the L1 price, the local supplier with the next higher bid within the margin of purchase preference shall be invited to match the L1 price and so on and contract shall be awarded accordingly. In case none of the local suppliers within the margin of purchase preference matches the L1 price, then the contract may be awarded to the L1 bidder.
4. **Exemption of small purchases:** Notwithstanding anything contained in paragraph 3, procurements where the estimated value to be procured is less than Rs. 5 lakhs shall be exempt from this Order. However, it shall be ensured by procuring entities that procurement is not split for the purpose of avoiding the provisions of this Order.
5. **Minimum local content:** The minimum local content shall ordinarily be 50%. The Nodal Ministry may prescribe a higher or lower percentage in respect of any particular item and may also prescribe the manner of calculation of local content.
6. **Margin of Purchase Preference:** The margin of purchase preference shall be 20%.
7. **Requirement for specification in advance:** The minimum local content, the margin of purchase preference and the procedure for preference to Make in India shall be specified in the notice inviting tenders or other form of procurement solicitation and shall not be varied during a particular procurement transaction.
8. **Government E-marketplace:** In respect of procurement through the Government E-marketplace (GeM) shall, as far as possible, specifically mark the items which meet the minimum local content while registering the item for display, and shall, wherever feasible, make provision for automated comparison with purchase preference and without purchase preference and for obtaining consent of the local supplier in those cases where purchase preference is to be exercised.
9. **Verification of local content:**
 - a. The local supplier at the time of tender, bidding or solicitation shall be required to provide self-certification that the item offered meets the minimum local content and shall give details of the location(s) at which the local value addition is made.
 - b. In cases of procurement for a value in excess of Rs. 10 crores, the local supplier shall be required to provide a certificate from the statutory auditor or cost auditor of the company (in the case of companies) or from a practicing cost accountant or practicing chartered accountant (in respect of suppliers other than companies) giving the percentage of local content.
 - c. Decisions on complaints relating to implementation of this Order shall be taken by the competent authority which is empowered to look into procurement-related complaints relating to the procuring entity.
 - d. Nodal Ministries may constitute committees with internal and external experts for independent verification of self-declarations and auditor's/ accountant's certificates on random basis and in the case of complaints.

.....Contd. p/4

- e. Nodal Ministries and procuring entities may prescribe fees for such complaints.
- f. False declarations will be in breach of the Code of Integrity under Rule 175(1)(i)(h) of the General Financial Rules for which a bidder or its successors can be debarred for up to two years as per Rule 151 (iii) of the General Financial Rules along with such other actions as may be permissible under law.
- g. A supplier who has been debarred by any procuring entity for violation of this Order shall not be eligible for preference under this Order for procurement by any other procuring entity for the duration of the debarment. The debarment for such other procuring entities shall take effect prospectively from the date on which it comes to the notice of other procurement entities, in the manner prescribed under paragraph 9h below.
- h. The Department of Expenditure shall issue suitable instructions for the effective and smooth operation of this process, so that:
 - i. The fact and duration of debarment for violation of this Order by any procuring entity are promptly brought to the notice of the Member-Convenor of the Standing Committee and the Department of Expenditure through the concerned Ministry /Department or in some other manner;
 - ii. on a periodical basis such cases are consolidated and a centralized list or decentralized lists of such suppliers with the period of debarment is maintained and displayed on website(s);
 - iii. in respect of procuring entities other than the one which has carried out the debarment, the debarment takes effect prospectively from the date of uploading on the website(s) in the such a manner that ongoing procurements are not disrupted.

10. Specifications in Tenders and other procurement solicitations:

- a. Every procuring entity shall ensure that the eligibility conditions in respect of previous experience fixed in any tender or solicitation do not require proof of supply in other countries or proof of exports.
- b. Procuring entities shall endeavour to see that eligibility conditions, including on matters like turnover, production capability and financial strength do not result in unreasonable exclusion of local suppliers who would otherwise be eligible, beyond what is essential for ensuring quality or creditworthiness of the supplier.
- c. Procuring entities shall, within 2 months of the issue of this Order review all existing eligibility norms and conditions with reference to sub-paragraphs 'a' and 'b' above.
- d. If a Nodal Ministry is satisfied that Indian suppliers of an item are not allowed to participate and/ or compete in procurement by any foreign government, it may, if it deems appropriate, restrict or exclude bidders from that country from eligibility for procurement of that item and/ or other items relating to that Nodal Ministry. A copy of every instruction or decision taken in this regard shall be sent to the Chairman of the Standing Committee.

.....Contd. p/5

- e. For the purpose of sub-paragraph 10 d above, a supplier or bidder shall be considered to be from a country if (i) the entity is incorporated in that country, or ii) a majority of its shareholding or effective control of the entity is exercised from that country; or (iii) more than 50% of the value of the item being supplied has been added in that country. Indian suppliers shall mean those entities which meet any of these tests with respect to India."

10A. Action for non-compliance of the Provisions of the Order: In case restrictive or discriminatory conditions against domestic suppliers are included in bid documents, an inquiry shall be conducted by the Administrative Department undertaking the procurement (including procurement by any entity under its administrative control) to fix responsibility for the same. Thereafter, appropriate action, administrative or otherwise, shall be taken against erring officials of procurement entities under relevant provisions. Intimation on all such actions shall be sent to the Standing Committee.

11. Assessment of supply base by Nodal Ministries: The Nodal Ministry shall keep in view the domestic manufacturing / supply base and assess the available capacity and the extent of local competition while identifying items and prescribing minimum local content or the manner of its calculation, with a view to avoiding cost increase from the operation of this Order.

12. Increase in minimum local content: The Nodal Ministry may annually review the local content requirements with a view to increasing them, subject to availability of sufficient local competition with adequate quality.

13. Manufacture under license/ technology collaboration agreements with phased indigenization: While notifying the minimum local content, Nodal Ministries may make special provisions for exempting suppliers from meeting the stipulated local content if the product is being manufactured in India under a license from a foreign manufacturer who holds intellectual property rights and where there is a technology collaboration agreement / transfer of technology agreement for indigenous manufacture of a product developed abroad with clear phasing of increase in local content.

14. Powers to grant exemption and to reduce minimum local content: The administrative Department undertaking the procurement (including procurement by any entity under its administrative control), with the approval of their Minister-in-charge, may by written order, for reasons to be recorded in writing,

- a. reduce the minimum local content below the prescribed level; or
- b. reduce the margin of purchase preference below 20%; or
- c. exempt any particular item or supplying entities or class or classes of items or procuring or supplying entities from the operation of this Order or any part of the Order.

A copy of every such order shall be provided to the Standing Committee and concerned Nodal Ministry / Department. The Nodal Ministry / Department concerned will continue to have the power to vary its notification on Minimum Local Content.

15. Directions to Government companies: In respect of Government companies and other procuring entities not governed by the General Financial Rules, the administrative Ministry or Department shall issue policy directions requiring compliance with this Order.

16. **Standing Committee:** A standing committee is hereby constituted with the following membership:

Secretary, Department for Promotion of Industry and Internal Trade—Chairman
Secretary, Commerce—Member
Secretary, Ministry of Electronics and Information Technology—Member
Joint Secretary (Public Procurement), Department of Expenditure—Member
Joint Secretary (DPIIT)—Member-Convenor

The Secretary of the Department concerned with a particular item shall be a member in respect of issues relating to such item. The Chairman of the Committee may co-opt technical experts as relevant to any issue or class of issues under its consideration.

17. **Functions of the Standing Committee:** The Standing Committee shall meet as often as necessary, but not less than once in six months. The Committee

- a. shall oversee the implementation of this order and issues arising therefrom, and make recommendations to Nodal Ministries and procuring entities.
- b. shall annually assess and periodically monitor compliance with this Order
- c. shall identify Nodal Ministries and the allocation of items among them for issue of notifications on minimum local content
- d. may require furnishing of details or returns regarding compliance with this Order and related matters
- e. may, during the annual review or otherwise, assess issues, if any, where it is felt that the manner of implementation of the order results in any restrictive practices, cartelization or increase in public expenditure and suggest remedial measures
- f. may examine cases covered by paragraph 13 above relating to manufacture under license/ technology transfer agreements with a view to satisfying itself that adequate mechanisms exist for enforcement of such agreements and for attaining the underlying objective of progressive indigenization
- g. may consider any other issue relating to this Order which may arise.

18. **Removal of difficulties:** Ministries /Departments and the Boards of Directors of Government companies may issue such clarifications and instructions as may be necessary for the removal of any difficulties arising in the implementation of this Order.

19. **Ministries having existing policies:** Where any Ministry or Department has its own policy for preference to local content approved by the Cabinet after 1st January 2015, such policies will prevail over the provisions of this Order. All other existing orders on preference to local content shall be reviewed by the Nodal Ministries and revised as needed to conform to this Order, within two months of the issue of this Order.

20. **Transitional provision:** This Order shall not apply to any tender or procurement for which notice inviting tender or other form of procurement solicitation has been issued before the issue of this Order.

(Arun Mahendru Baraj)
Senior Development Officer
Tel: 2306 2635

ANNEXURE-5 QP FORMAT

MANUFACTURER'S NAME AND ADDRESS		QUALITY PLAN				TO BE FILLED BY BHEL		TO BE FILLED BY BHEL						
BHEL	VENDOR'S NAME	ITEM		QP NO.										
				REV										
		DRG. NO.		AS PER PO										
		SPEC.		AS PER PO										
		REV						Page 1 of 1						
SL. NO.	COMPONENT & OPERATIONS	CHARACTERISTICS	CLASS	TYPE OF CHECK	QUANTUM OF CHECK	REFERENCE DOCUMENT	ACCEPTANCE NORMS	FORMAT OF RECORDS		AGENCY			REMARKS	
1	2	3	4	5	6	7	8	9	D	10	M	B	N	11

		LEGEND: ! RECORDS IDENTIFIED WITH 'TICK' UNDER COULMN "D" SHALL BE ESSENTIALLY INCLUDED BY CONTRACTOR IN QA DOCUMENTATION. M: MANUFACTURER / SUBCONTRACTOR B: BHEL / NOM. INSPECTION AGENCY N: CUSTOMER INDICATE 'P' PERFORM 'W' WITNESS AND 'V' VERIFICATION ALL 'W' INDICATED IN COLUMN 'N' SHALL BE 'CHP' OF CUSTOMER	FOR CUSTOMER USE	
MANUFACTURER/SUBCONTRACTOR				APPROVED BY

ANNEXURE-6 (SPECIFICATION)

संस्थान क्रय विनिर्देश (हीप - हरिद्वार)

PLANT PURCHASE SPECIFICATION (HEEP - HARIDWAR)

HW 10679

पृष्ठ का
Page 1 of 8



HEAT RESISTANT STEEL BARS FOR TURBINE BLADES, GRADE: X13CrMoCoVNbNB9-2-1 (FB2)

1.0 General:

This specification governs the quality of Steel rectangular bars in steel grade X13CrMoCoVNbNB9-2-1 (FB2). Material as per TLV9265 04 Oct'2014 from Collaborators approved supplier is also acceptable.

2.0 Application:

For machined/milled blades for Steam Turbine.

3.0 Condition of Delivery:

Rolled or Forged and Heat Treated.

4.0 Dimension and Tolerances:

Dimensional tolerance, straightness, twisting and bulging limits shall be as per HW0993008.

5.0 Manufacture:

Electro slag re-melted steel (ESR) shall be used.

The manufacturing process must ensure a homogenous grain structure over the entire length of the bar and the bar cross section.

6.0 General Requirements:

- Prerequisite requirement for approval of a new vendor (other than Collaborator approved vendor) is a successful Process qualification. Manufacturing process established during this shall be the basis for future manufacture.
- Manufacturing plan shall be prepared and submitted after successful process qualification. Manufacturing plan shall include specific information on manufacturing like rolling temperature, reduction ratio, heat treatment temperature, hardening method and soaking time, rate of heating and cooling etc. Test instructions for nondestructive and destructive testing are to be provided in the manufacturing and testing plan.
- Product and process qualification is mandatory for each of the suppliers manufacturing plants.
- For new supplier (other than Collaborator approved vendor), process qualification shall be required for three purchase orders.
- If necessary, BHEL may ask for process qualification for verification of manufacturing reliability from regular suppliers also.
- Any change in the agreed manufacturing plan shall be informed to BHEL. BHEL will review the requirement of renewed process qualification.

हस्ताक्षर एवं दिनांक
SIGN & DATE

सुपरसेडस
INVENTORY NO.
सामग्री सूची संख्या को
अधिकृतित करता है
TLV 9265/04, Oct'14

स्वत्वाधिकार एवं गोपनीय ;
इस प्रलेख में दी गई सूचना भारत हेवी इलेक्ट्रिकल्स की संपत्ति है इसका प्रत्यक्ष एवं अप्रत्यक्ष रूप से किसी भी तरह प्रयोग, जो कि कम्पनी के हित में हानिकारक हो ना किया जाए

हस्ताक्षर एवं दिनांक
SIGN & DATE

सामग्री सूची संख्या
INVENTORY NO.
R 4130

TSX	V.Srivastava	26/5/18	नाम NAME	हस्ताक्षर एवं दिनांक SIGNATURE & DATE
PSC	G. Krishnan	26/5/18	अनुवादक TRANSLATED BY	
QAX	U. K. Panda	26/5/18	निर्माणकर्ता WORKED BY	SUBODH RANA
STE	S.K. Gang	23.05.2018	जांचकर्ता CHECKED BY	ASHISH RANJAN
सहमत विभाग AGREED DEPTT.	नाम NAME	दिनांक एवं हस्ताक्षर DATE & SIGNATURE	पर्यवेक्षणकर्ता SUPERVISED BY	GOPAL KRISHNAN
REV NO.	00	स्वीकृति : संस्थान मानक समिति APPROVED : PLANT STANDARDS COMMITTEE	Gr. No	2.60
DATE	29.05.2018	निर्माण PREPARED : MTE	जारी : मानक विभाग ISSUED : STANDARDS DIVISION	दिनांक DATE : 25.05.18
C/A NO.				



संस्थान क्रय विनिर्देश (हीप - हरिद्वार)
PLANT PURCHASE SPECIFICATION
 (HEEP - HARIDWAR)

HW 10679

पृष्ठ का
 Page 2 of 8

हस्ताक्षर एवं दिनांक
 SIGN & DATE

सामग्री सूची संख्या को
 SUPERSEDES
 INVENTORY NO.

सामग्री सूची संख्या को
 COPYRIGHT AND CONFIDENTIAL
 The information on this document is the property of Bharat Heavy Electrical Limited. It must not be used directly or indirectly in any way detrimental to the interest of the company

स्वत्वधिकार एवं गोपनीय ;
 इस दस्तावेज में दी गई सूचना भारत हेवी इलेक्ट्रीकल्स की सम्पत्ति है। इसका प्रयोग एवं आसक्त रूप से किसी भी तरह प्रयोग, जो कि सम्पत्ती के हित में हानिकारक हो ना किया जाय

सामग्री सूची संख्या
 INVENTORY NO.
 P-6130

7.0 Heat Treatment:

Hardening:

Hardening temperature shall be 1100°C (air or liquid quenching, cooled down to a temperature < 100°C in the center of the bar)

Tempering:

A two-step tempering treatment must be performed as follows:

- The first tempering must be carried out at a temperature of 570°C and holding time of ≥ 4h. Air has to be used for cooling.
- Temperature of second tempering step has to be ≥ 690°C.

A fully transformed and tempered martensitic microstructure must be present over the entire cross section.

Hardening and tempering in bundles are not allowed. Suitable gaps between two bars are to be ensured during heat treatment for uniformity of properties.

If bars need to be straightened after the heat treatment, a stress relieving heat treatment shall be performed after completion of entire straightening process. Stress relieving is to be carried out at 20 - 30°C below the tempering temperature with a subsequent slow cooling rate.

The lowest possible residual stresses shall be targeted. Distortion of the finish machined part due to residual stresses from the manufacturing process or heat treatment process shall not occur.

8.0 Properties and their verification:

8.1 Chemical Composition:

Heat analysis in weight %

C	Si	Mn	P	S	Cr	Mo
0.12 - 0.15	≤ 0.10	0.30 - 0.50	≤ 0.010	≤ 0.005	9.0 - 9.4	1.40 - 1.60
Ni	Co	V	Nb	N	Al	B
0.10 - 0.20	0.90 - 1.30	0.15 - 0.25	0.040 - 0.060	0.015 - 0.030	≤ 0.010	80 - 110 ppm

Trace element content for Ti, Cu, As, Sb and Sn must be specified in the inspection certificate for information purposes.

8.2 Properties and Microstructure:

The specimens shall be taken in the longitudinal direction in accordance with Attachment 1. The properties described below shall be determined at room temperature in the delivery condition, i. e. after the last heat treatment including any stress relieving heat treatment.

The metallographic investigations shall be performed on the hardest and softest bar with an area of at least 320mm² each. The areas to be investigated must be in the longitudinal direction. The longitudinal direction must be indicated in the documentation.

8.2.1 Mechanical Properties:

Hardness of the bars in a test unit shall be verified by Brinell hardness testing in accordance with ISO 6506 -1, HBW10/3000 or HBW 5/750 may be used.

REV 00

निर्माणकर्ता WORKED BY	Ashish Ranjan	<i>A.Ranjan</i>	26/5/18
जांचकर्ता CHECKED BY	Gopal Krishnan	<i>G.Krishnan</i>	26/5/18



संस्थान क्रय विनिर्देश (हीप - हरिद्वार)
PLANT PURCHASE SPECIFICATION
 (HEEP - HARIDWAR)

HW 10679

पृष्ठ का
 Page 3 of 8

हस्ताक्षर एवं तिथि
 SIGN & DATE

समयी सूची संख्या को
 अधिकारित करना है

COPYRIGHT AND CONFIDENTIAL
 The information on this document is the property of Bharat Heavy Electricals Limited. It must not be used directly or indirectly in any way detrimental to the interest of the company

स्वत्वाधिकार एवं गोपनीय ;
 इस प्रलेख में दी गई सूचना भारत हीवी इलेक्ट्रिकल्स की सम्पत्ति है इसका प्रत्यक्ष एवं अप्रत्यक्ष रूप से किसी भी तरह प्रयोग, ओर बिना कम्पनी के हित में प्रतिकारक हो ना किया जाए

हस्ताक्षर एवं तिथि
 SIGN & DATE

समयी सूची संख्या
 INVENTORY NO.

The surface of the bar shall be prepared in the area of the hardness measurement so that the result is not affected by the surface condition.

Hardness testing shall be performed on 10% of each test unit but at least on 10 bars or on each bar if test unit is less than 10 bars. The greatest resulting difference in hardness shall not exceed 35HBW.

Mechanical properties shall be determined on the hardest and softest bar determined in a test unit.

The requisite properties are to be maintained over the entire cross section of the bar, where the difference between strength values (0.2% Proof Stress and Tensile Strength) shall not be more than 7.5% of respective maximum.

Tensile testing shall be performed in accordance with ISO 6892 -1 or ASTM E8M (round specimen with $L_0 = 50\text{mm}$ and $d_0 = 10\text{mm}$) or ASTM E8M (standard specimen in accordance with Figure 8).

Standard specimens Charpy (V-notch) in accordance with ISO 148 -1 shall be used for determining the absorbed impact energy.

The following properties must be achieved at room temperature:

0.2 % Proof Stress (N/mm ²)	Tensile Strength (N/mm ²)	Elongation After Fracture (%)	Reduction in area %	Impact Energy (J) ¹	Hardness HBW
730 - 830	870 - 970	≥ 14	≥ 50	≥ 40	270 - 310

¹ Average of 3 specimens and minimum value for two specimens in accordance with EN10021, where the lowest value shall be at least 30 Joule.

Additionally, on the softest bar a tensile test in accordance with ISO 6892 - 2 has to be performed (in longitudinal direction) at 625°C. The following properties must be achieved:

0.2 % Proof Stress (N/mm ²)	Tensile Strength (N/mm ²)	Elongation After Fracture (%)	Reduction in area (%)
≥ 360	≥ 385	≥ 19	≥ 70

8.2.2 Microstructure:

Microstructure must be uniform, without porosity, excessive segregation or other inhomogeneities.

8.2.2.1 Cleanliness:

The cleanliness shall be determined as per DIN 50602 - K1. A minimum of 4 specimens per heat shall be used for determination of cleanliness.

Acceptance criteria:

Summary value K1: ≤ 2.0 (relating to 1000mm²)

8.2.2.2 Delta Ferrite content and grain size:

- Delta ferrite content shall be < 5%. The determination of delta ferrite content shall be performed based on analysis method in accordance with ASTM E45 method A, "Worst field method" with V=100:1.

8.3 Non-destructive Testing:

8.3.1 Test Scope:

The following Non – destructive inspections shall be performed in the as delivered condition:

- Visual inspections of all bars
- Ultrasonic examination of all bars in accordance with TWP 1204, 03/25.10.2012. 100% of the volume must be tested in accordance with the recording level.

REV 00

निर्माणकर्ता WORKED BY	Ashish Ranjan	<i>Ashish</i>	26/5/18
जांचकर्ता CHECKED BY	Gopal Krishnan	<i>Gopal</i>	26/5/18

12-4130

<p>हस्ताक्षर एवं दिनांक SIGN & DATE</p> <p>सामग्री सूची संख्या को अधिकृतित करना है</p> <p>सामग्री सूची संख्या को अधिकृतित करना है</p> <p>स्वत्वधिकार एवं गोपनीय ; इस प्रलेख में दी गई सूचना भारत हेवी इलेक्ट्रीकल्स की सम्पत्ति है इसका प्रत्यक्ष एवं अप्रत्यक्ष रूप से किसी भी तरह प्रयोग , जो कि कम्पनी के हित में हानिकारक हो या किया जाए</p> <p>हस्ताक्षर एवं दिनांक SIGN & DATE</p> <p>सामग्री सूची संख्या INVENTORY</p>	 <p>संस्थान क्रय विनिर्देश (हीप - हरिद्वार)</p> <p>PLANT PURCHASE SPECIFICATION</p> <p>(HEEP - HARIDWAR)</p> <p>HW 10679</p> <p>पृष्ठ का Page 4 of 8</p> <p>सुपरसेडेस INVENTORY NO.</p> <p>COPYRIGHT AND CONFIDENTIAL The information on this document is the property of Bharat Heavy Electrical Limited. It must not be used directly or indirectly in any way detrimental to the interest of the company</p>	<ul style="list-style-type: none"> An average grain size of 3 or finer has to be achieved. Grain size shall be determined on the martensitic secondary grain structure in accordance with ASTM E112 or ISO643. A deviation of more than 2 grain sizes in size of individual's grains from the average grain size is not allowable. <p>8.3.2 Recording level and acceptance criteria:</p> <ul style="list-style-type: none"> Indications of surface defects such as rolled marks shall be ground out to investigate their depth at least at both ends, in the middle of the indication and at an interval of approx. 250mm. Surface defects with a depth extension of $\geq 1\text{mm}$ are not allowable, and these areas shall be cut out of the bar. Ultrasonic examination and acceptance of all bars in accordance with TWP 1204. Defects above the recording level are not acceptable. It shall be confirmed in writing to the BHEL that bar sections containing defects above the recording level have been cut out of the bar. The acceptance of material at vendor's works does not relieve the supplier of his responsibility for defects discovered at later stages. <p>8.3.3 Material Identity Test: An identity test must be conducted on 100% of bars in the as – delivered condition.</p> <p>9.0 Process Qualification: The following additional investigations shall be performed in process qualification (see Attachment 2):</p> <ul style="list-style-type: none"> Tensile tests: The strength values (0.2% Proof Stress and Tensile Strength) in the transverse direction (specimen orientation ZQ) shall not differ by more than 10% from the corresponding longitudinal values. The smallest individual value for absorbed impact energy in transverse direction shall not be below 30J. For case where standard specimens in transverse direction cannot be made: - <ul style="list-style-type: none"> For tensile test specimens, a round specimen with $L_0 = 5 d_0$ or a flat specimen with a proportionality factor of $k= 5.65$. Proportional specimens in accordance with Fig 8 shall be used if ASTM E8 is applied. <ul style="list-style-type: none"> An undersized specimen in accordance with ISO 148 -1 for impact test specimen. Undersize dimension to be reported. If dimension do not allow testing in the transverse direction, even with special specimen, testing will be carried out in the longitudinal direction only. FATT: Determination of FATT (fracture appearance transition temperature) in accordance with ASTM A370. The FATT should be preferably evaluated based on SEP 1670 (software). The test scope must include at least 10 specimens. $FATT < 25^\circ\text{C}$ is to be achieved. The fraction of Intergranular fracture shall be determined over the entire brittle fracture portion of the fracture surface of the impact test specimens tested at room temperature. The fraction of Intergranular fracture shall not exceed 10%. This test is not required for materials which indicate $\geq 90\%$ ductile fracture at room temperature. Performance of MT testing by magnetic flux leakage method, alternating current phase shifted and a field strength of 20-65A/cm. Distribution, type and size of grain structure in-homogeneities (e.g. segregation or delta ferrite) shall not result in MT indications. 	<p>निर्माणकर्ता WORKED BY</p> <p>Ashish Ranjan</p> <p>जांचकर्ता CHECKED BY</p> <p>Gopal Krishnan</p> <p>26/5/18</p> <p>26/5/18</p>
<p>सामग्री सूची संख्या INVENTORY</p> <p>P-4/130</p>	<p>REV 00</p>		<p>निर्माणकर्ता WORKED BY</p> <p>Ashish Ranjan</p> <p>जांचकर्ता CHECKED BY</p> <p>Gopal Krishnan</p> <p>26/5/18</p> <p>26/5/18</p>



संस्थान क्रय विनिर्देश (हीप - हरिद्वार)

PLANT PURCHASE SPECIFICATION
(HEEP - HARIDWAR)

HW 10679

पृष्ठ का
Page 5 of 8

हस्ताक्षर एवं दिनांक
SIGN & DATE

सुपरसेडिज
INVENTORY NO.
सामग्री सूची संख्या को
सुपरसेडिज कराया है

COPYRIGHT AND CONFIDENTIAL
The information on this document is the property of Bharat Heavy Electrical Limited. It must not be used directly or indirectly in any way detrimental to the interest of the company

स्वत्वाधिकार एवं गोपनीय ;
इस प्रलेख में दी गई सूचना भारत हेवी इलेक्ट्रिकल्स की सम्पत्ति है इसका प्रयोग एवं प्रसारण
इस से किसी भी तरह प्रयोग , जो कि कम्पनी के हित में हानिकारक हो ना किया जाए

हस्ताक्षर एवं दिनांक
SIGN & DATE

सामग्री सूची संख्या
INVENTORY NO.

- A creep rupture test on the softest bar in accordance with ISO 204 with determination of creep limits is to be performed at 650°C with an initial stress of 150MPa. The following requirement has to be fulfilled:
Rupture Time > 500. The test has to be performed up to rupture.
Creep limits, creep rupture time, elongation after creep rupture and reduction of area after creep rupture have to be submitted.
BHEL will review all result and based on result HCF test may also be asked for qualification.
- **All test results shall be submitted to BHEL for approval.**

10.0 Identification Marking:

All bars are to be marked with following information:

- Purchase Order Number
- Size
- Material Grade
- Supplier Identification

The details are to be clearly stamped and encircled by oil paint. Each bar shall be painted with a band of colour **orange - blue - orange** on both ends. All the bars shall be suitably packed to protect them against corrosion and damage during transportation.

Bars having maximum and minimum hardness (from which test samples are taken) shall be clearly marked by oil paint for easy identification. Their respective hardness values shall also be punched on these bars.

11.0 Documentation:

Prior to, but in no case later than the delivery of the material, an inspection certificate as per EN 10204 shall be provided to BHEL in duplicate; this certificate must contain the following data:

- (a) Material code no and P.O. number
- (b) Material designation
- (c) Heat no., heat analysis and melting methods
- (d) Complete information on all heat treatments performed
- (d) Mechanical test results including hardness range and the metallurgical examination.
- (e) Results of non-destructive tests, UT inspection report
- (f) Confirmation of the material identity check
- (g) Confirmation of the dimensions and visual inspection

12.0 Cross Referred Standard:

HW0993008, ISO 6506 -1, ISO 6892 – 1, ISO 6892 – 2, ASTM E8M, ISO 148 – 1, EN10021, ASTM E45, ASTM E112, ISO 643, DIN50602, TWP 1204, ASTM A370, EN10204

REV 00

निर्माणकर्ता
WORKED BY

Ashish
Ranjan

Ashish Ranjan 26/5/18

जांचकर्ता
CHECKED BY

Gopal
Krishnan

Gopal Krishnan 26/5/18

P-4/30



संस्थान क्रय विनिर्देश (हीप - हरिद्वार)
PLANT PURCHASE SPECIFICATION
 (HEEP - HARIDWAR)

HW 10679

पृष्ठ का
 Page 6 of 8

हस्ताक्षर एवं तिथि
 SIGN & DATE

सामग्री सूची संख्या को
 सुपरीक्षणित करना है

सुपरसेडस
 INVENTORY NO

स्वत्वधिकार एवं गोपनीय ;
 इस प्रलेख में दी गई सूचना भारत हिरो इलेक्ट्रिकल्स की सम्पत्ति है इसका प्रत्यक्ष एवं अप्रत्यक्ष रूप से किसी भी तरह प्रयोग, जो कि कम्पनी के हित में हानिकारक हो गा किया जाए

हस्ताक्षर एवं तिथि
 SIGN & DATE

सामग्री सूची संख्या
 INVENTORY

Attachment 1

Standard Testing

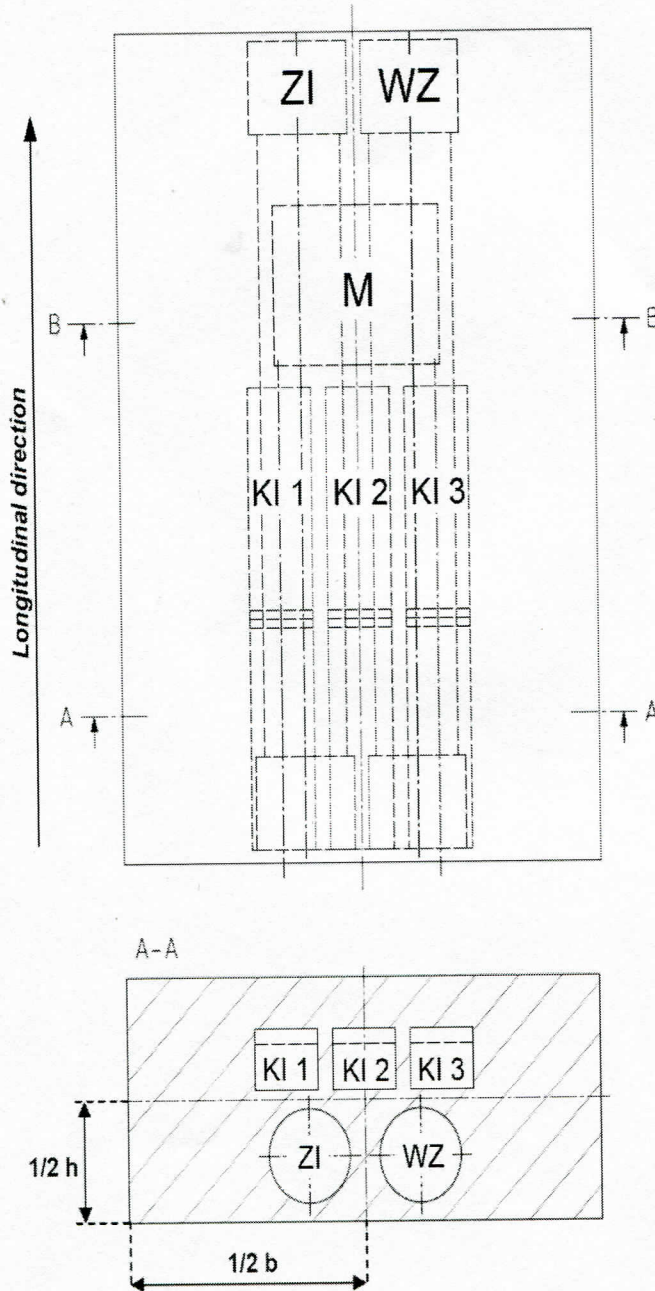

Label	Specimen
ZI	Tensile Specimen Centre
WZ*	Hot Tensile Specimen
KI 1 - KI 3	Notched Impact Specimen Centre
M	Metallographic Specimen

* if required in material specification

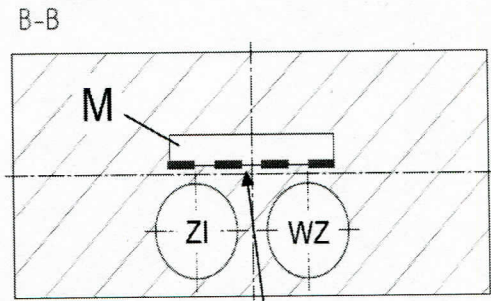

Lower Surface of the Metallographic Specimen has to be examined. Longitudinal direction must be indicated in the documentation. $A \geq 320 \text{ mm}^2$

REV 00

निर्माणकर्ता WORKED BY	Ashish Ranjan	<i>Ashish</i>	26/5/18
जांचकर्ता CHECKED BY	Gopal Krishnan	<i>Gopal</i>	26/5/18



संस्थान क्रय विनिर्देश (हीप - हरिद्वार)
PLANT PURCHASE SPECIFICATION
 (HEEP - HARIDWAR)

HW 10679

पृष्ठ का
 Page 7 of 8

हस्ताक्षर एवं दिनांक
 SIGN & DATE

SUPERSEDES
 INVENTORY NO

सामग्री सूची संख्या को
 प्रतिबन्धित करना है

COPYRIGHT AND CONFIDENTIAL
 The information on this document is the property of Bharat Heavy Electrical Limited. It must not be used directly or indirectly in any way detrimental to the interest of the company

स्वत्वाधिकार एवं गोपनीयता :
 इस प्रलेख में दी गई सूचना भारत हेवी इलेक्ट्रिकल्स की सम्पत्ति है इसका प्रयोग एवं प्रसारण
 रूप से किसी भी तरह प्रयोग, जो कि सम्पत्ती के हित में हानिकारक हो ना किया जाए

हस्ताक्षर एवं दिनांक
 SIGN & DATE

सामग्री सूची संख्या
 INVENTORY

Attachment 2, Page 1/2

Process Qualification

Longitudinal direction

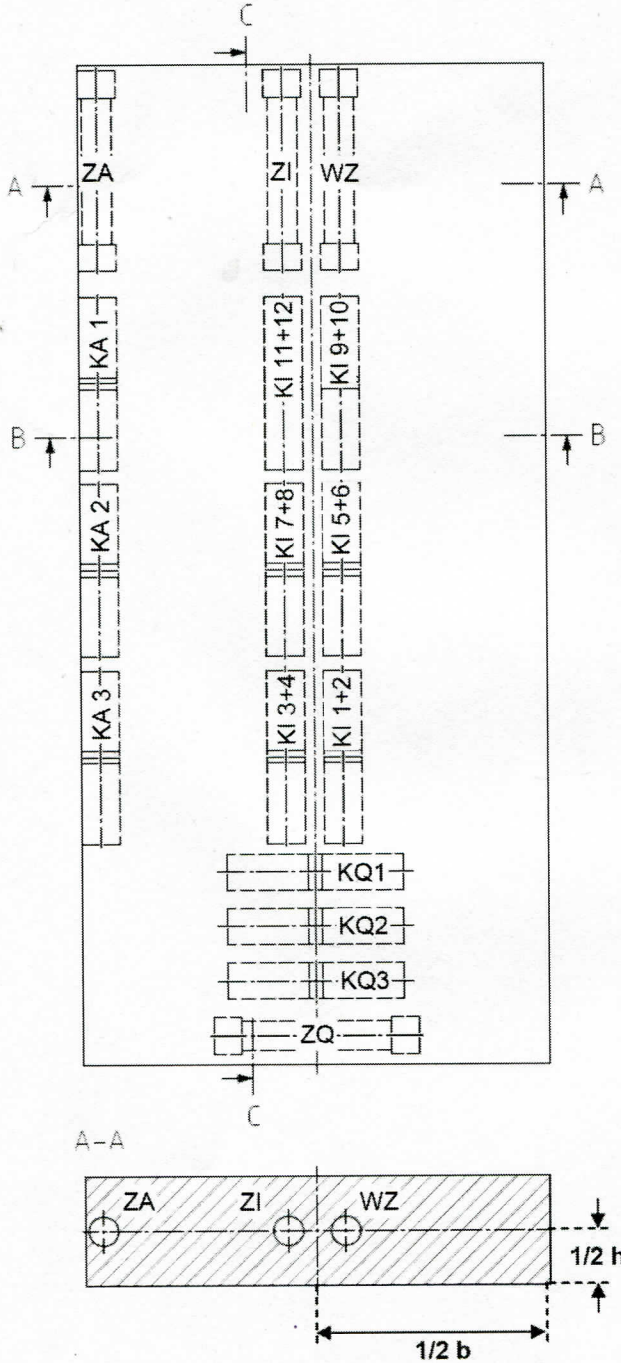

Label	Specimen
ZI	Tensile Specimen Centre
ZA	Tensile Specimen Rim
ZQ	Tensile Specimen Transverse
WZ*	Hot Tensile Specimen
KI 1 - KI 12	Notched Impact Specimen Centre (FATT)
KA 1 - KA 3	Notched Impact Specimen Rim
KQ 1 - KQ 3	Notched Impact Specimen Transverse

* if required in material specification

Note the notch positions of the notch impact specimens (see B - B and C - C).

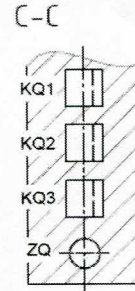
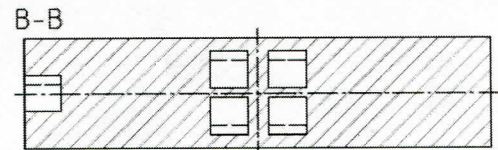

REV 00

निर्माणकर्ता WORKED BY	Ashish Ranjan	<i>Ashish</i>	26/5/18
जांचकर्ता CHECKED BY	Gopal Krishnan	<i>Gopal</i>	26/5/18

हस्ताक्षर एवं दिनांक
SIGN & DATE



संस्थान क्रय विनिर्देश (हीप - हरिद्वार)
PLANT PURCHASE SPECIFICATION
(HEEP - HARIDWAR)

HW 10679

पृष्ठ का
Page 8 of 8

SUPERSEDES
INVENTORY NO

सामग्री सूची संख्या को
संश्लेषित करता है

COPYRIGHT AND CONFIDENTIAL
The information on this document is the property of Bharat Heavy Electrical Limited. It must not be used directly or indirectly in any way detrimental to the interest of the company

स्वत्वधिकार एवं गोपनीय ;
इस प्रलेख में दी गई सूचना भारत हेवी इलेक्ट्रिकल्स की सम्पत्ति है। इसका प्रत्यक्ष एवं अप्रत्यक्ष रूप से किसी भी तरह प्रयोग, जो कि सम्पत्ती के हित में हानिकारक हो ना किया जाए

हस्ताक्षर एवं दिनांक
SIGN & DATE

सामग्री सूची संख्या
INVENTORY

Attachment 2, Page 2/2

Process Qualification

Label	Specimen
M	Metallographic Specimen
MP	Specimen for Magnetic Particle Test

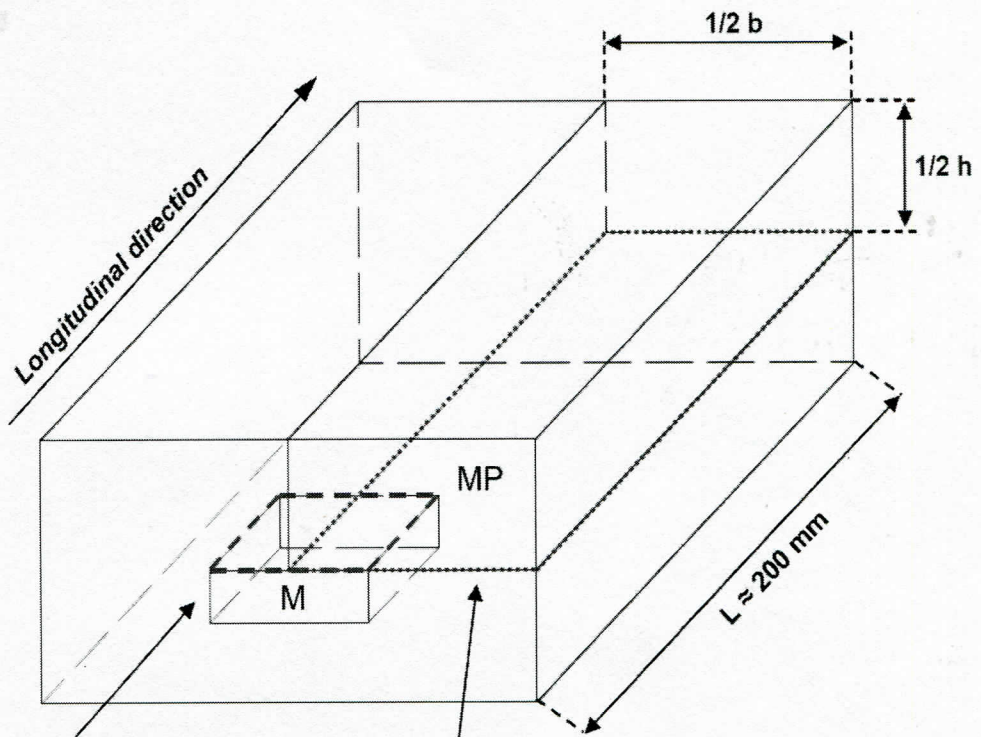

Upper Surface of the Metallographic Specimen has to be examined. Longitudinal direction must be indicated in the documentation. $A \geq 320 \text{ mm}^2$

Lower Surface of the specimen has to be examined in Magnetic Particle Test.

REV 00

निर्माणकर्ता WORKED BY	Ashish Ranjan		26/5/18
जांचकर्ता CHECKED BY	Gopal Krishnan		26/5/18

ANNEXURE-6 (SPECIFICATION)

दिनांक एवं हस्ताक्षर SIGN & DATE		<h2 style="margin: 0;">संस्थान मानक (हीप : हरिद्वार)</h2> <h3 style="margin: 0;">PLANT STANDARD (HEEP: HARIDWAR)</h3>	HW0993008 पृष्ठ 2 का 1 Page 1 of 2
-------------------------------------	---	---	---

Own Experience

DIMENSION AND TOLERANCES OF BAR MATERIAL OF BLADES FOR SPEC NO HW10663, HW10670, HW10786, HW10687

1. Dimension & Tolerances:
 The dimension shall be as per purchase order. Unless otherwise stated in the purchase order, length or bars shall be 2.5- 5 meters with maximum 10% short down to 1 meter.

Tolerance on thickness and width are as follows:

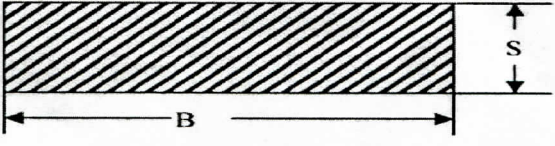
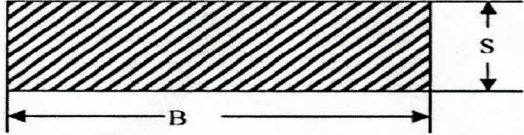

Table: 1

B, width across flats (mm)	Max Allowable deviation on B, mm	S, Thickness (mm)	Max Allowable deviation on S, mm
$B \leq 35$	+1.5	$S \leq 20$	+1
$35 < B \leq 75$	+2	$20 < B \leq 40$	+2
$B > 75$	+3	$S > 40$	+3

Twisting and bending will be allowed as per following table: 2



COPYRIGHT AND CONFIDENTIAL
 The information on this documents is the property of Bharat Heavy Electrical Limited. It must not be used directly or indirectly in any way detrimental to the interest of the company

स्वाधिकार एवं गोपनीय
 इस प्रलेख में दी गई सूचना भारत हेवी एलेक्ट्रिकल लिमिटेड की सम्पत्ति है. इसका प्रयुक्त एवं अप्रयुक्त रूप में किसी भी तरह प्रयोग ओ कि कंपनी के हित में हानिकारक हो न किया जाए.

दिनांक एवं हस्ताक्षर SIGN & DATE <i>02/05/17</i>	दिनांक एवं हस्ताक्षर SIGN & DATE <i>02/05/17</i>	दिनांक एवं हस्ताक्षर SIGN & DATE <i>02/05/17</i>	दिनांक एवं हस्ताक्षर SIGN & DATE <i>02/05/17</i>	दिनांक एवं हस्ताक्षर SIGN & DATE <i>02/05/17</i>	दिनांक एवं हस्ताक्षर SIGN & DATE <i>02/05/17</i>
MTE	A.RANJAN	<i>Ranjana</i>		नाम NAME	दिनांक एवं हस्ताक्षर SIGNATURE & DATE
TSX	Lalit Kumar	<i>Lalit Kumar</i>	निर्माणकर्ता WORKED BY	ANIL KUMAR	<i>Anil Kumar</i> 02/05/17
STE-TB	Ramesh	<i>Ramesh</i>	जांचकर्ता CHECKED BY	RAJIV KUMAR RAJAK	<i>Rajiv Kumar</i> 21/5/17
QAX	U.K.Panda	<i>U.K.Panda</i>	स्वीकृतकर्ता APPROVED BY	NEETU KUMAR SINGLA	<i>Neetu Kumar Singla</i> 02/05/17
सहमत विभाग AGREED DEPTT.	नाम NAME	दिनांक एवं हस्ताक्षर DATE & SIGNATURE	पर्यवेक्षणकर्ता SUPERVISED BY	VIJAY KUMAR CHUGH	<i>Vijay Kumar Chugh</i> 02/05/17
			स्वीकृति संस्थान मानकीकरण समिति APPROVED : PLANT STANDARDIZATION COMMITTEE		
REV.NO.	00		निर्माण PREPARED : TBM	जारी ISSUED : TSX	Gr. No. 6.40
Di.	02.05.17				दिनांक DATE : 02.05.2017
CHANGE ADVICE NO.					



संस्थान मानक (हीप : हरिद्वार)

HW0993008

PLANT STANDARD (HEEP : HARIDWAR)

पृष्ठ 2 का 2

Page 2 of 2

Table:2

Condition	Bending	Twisting
B & S both ≤ 110	1.5 mm/meter	1.5 mm/meter
B or S > 110	2 mm/meter	2 mm/meter

Table 3: Straightness tolerances (q_{max}) for rectangular section bar

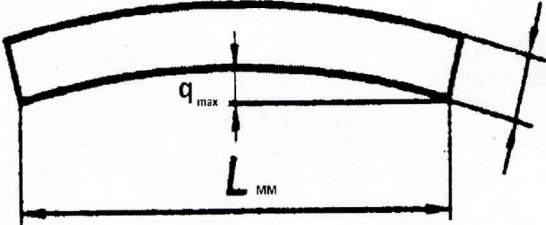
Straightness	Value of q_{max} (mm)	Condition
	$(L \times 1.5)/2000$	B & S both ≤ 110
	$(L \times 2)/2000$	B or S > 110

Bulging on the sides shall not be more than $0.01 \times B$ & $0.02 \times S$ respectively

Table 4: Out of section tolerance for rectangular section bar:

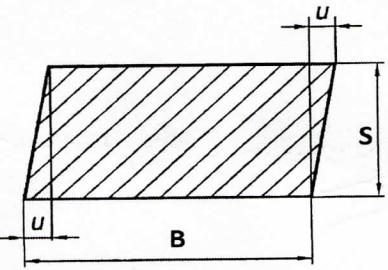
Out of section	Nominal Thickness (mm)	Tolerance(mm)
	$10 < S \leq 25$	$u \leq 0.5$
	$25 < S \leq 40$	$u \leq 1.0$
	$40 < S \leq 80$	$u \leq 1.5$
	$S > 80$	$u \leq 3.0$

2. Cross referred documents: HW10663, HW10670, HW10786 & HW10687.

दिनांक एवं तिथि
SIGN & DATE

SUPERSEDES
INVENTORY

सामग्री सूची संख्या को
अपडेट किया गया है



COPYRIGHT AND CONFIDENTIAL
The information on this documents is the property of Bharat Heavy Electrical Limited. It must not be used directly or indirectly in any way detrimental to the interest of the company

स्वत्वाधिकार एवं गोपनीय
इस प्रलेख में की गई सूचना भारत हेवी इलेक्ट्रिकल्स लिमिटेड की सम्पत्ति है। इसका प्रयोग एवं प्रसारण के बिना की तरह प्रयोग जो कि कंपनी के हित में हानिकारक हो न किया जाए।

दिनांक एवं तिथि
SIGN & DATE

सामग्री सूची संख्या
INVENTORY NO.

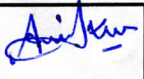
REV. NO. 00

निर्माणकर्ता WORKED BY	ANIL KUMAR		2/5/17
जांचकर्ता CHECKED BY	RAJIV KUMAR RAJAK		2/5/17

P-4123